

DDMP FAN

Operating Manual

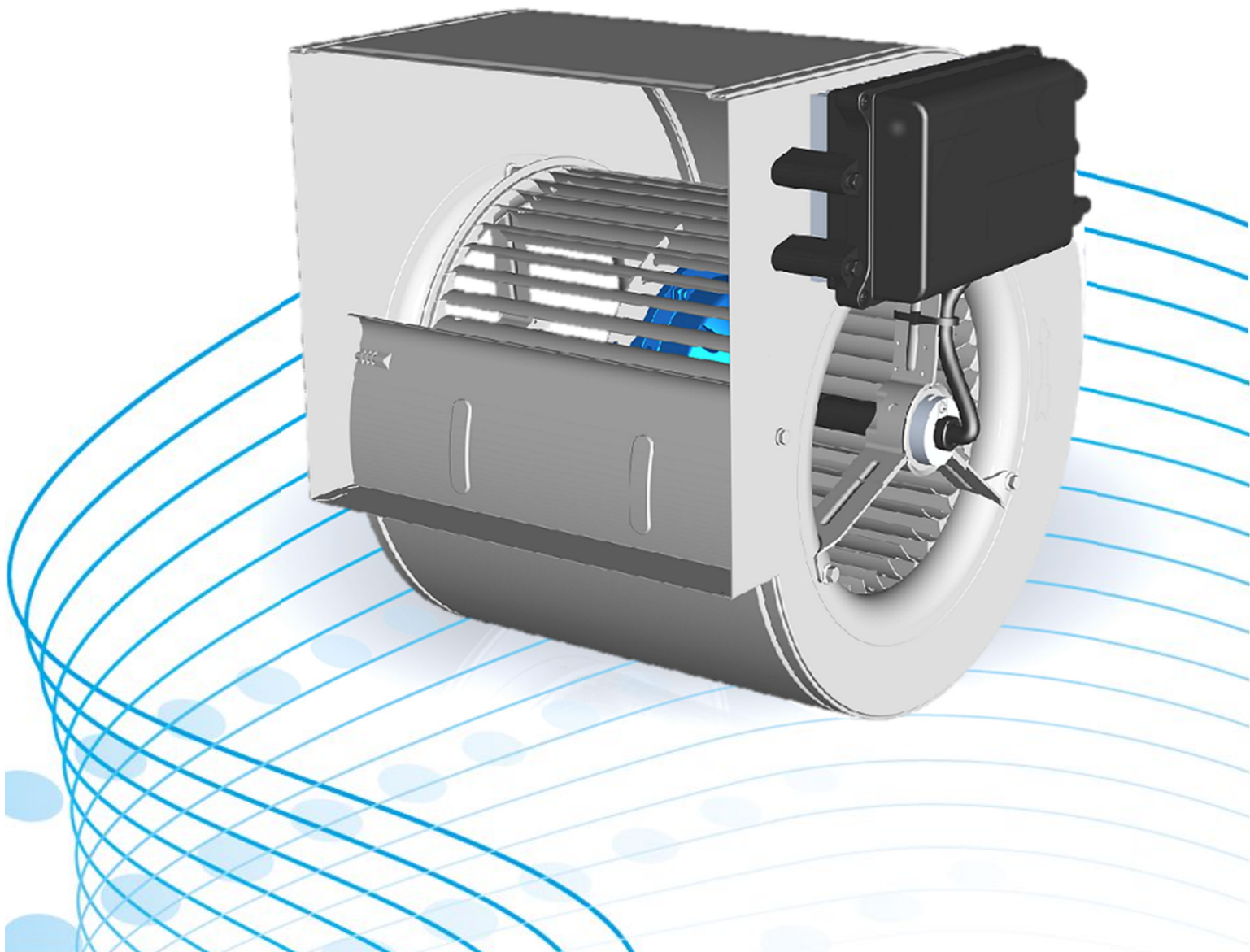

TABLE OF CONTENTS

1- DEFINITIONS AND WARNINGS	Pag.4
1.0.1- Qualified Personnel	Pag.4
1.0.2- Use for intended purpose only	Pag.4
1.1- Read carefully	Pag.4
1.2- Safety Instructions	Pag.5
1.3- General	Pag.5
1.4- Transport & Storage	Pag.6
1.5- Commissioning	Pag.6
1.6- Operation	Pag.6
1.7- Repair	Pag.6
1.8- Declaration of conformity	Pag.7
1.8.1- Electromagnetic Compatibility	Pag.7
2- PRODUCT OVERVIEW	Pag.7
2.0.1- General Information	Pag.7
2.0.2- 1kW Driver	Pag.8
2.0.3- 2kW Driver	Pag.8
2.0.4- Features	Pag.9
2.0.5- Performance	Pag.9
2.0.6- Protection	Pag.9
2.0.7- Ambient Operating Conditions	Pag.9
3- CONNECTIONS	Pag.10
3.0.1- Power supply connection:	Pag.11
3.0.2- Control Board connection:	Pag.11
4- OPERATING MODES	Pag.13
4.1- Speed Control	Pag.14
4.1.1- Analog Speed Control	Pag.14
4.1.2- Modbus Speed Control	Pag.14
4.1.3- Modbus Fixed Speed Control	Pag.14
4.1.4- Speed Control curves example	Pag.14
4.2- Constant Airflow	Pag.15
4.2.1- Analog Constant Airflow	Pag.15
4.2.2- Modbus Constant Airflow	Pag.16
4.2.3- Modbus Fixed Constant Airflow	Pag.16
4.2.4- Constant Airflow curves example	Pag.16
4.3- Asynchronous Emulation	Pag.17
4.3.1- Analog Asynchronous Emulation	Pag.17
4.3.2- Modbus Asynchronous Emulation	Pag.17
4.3.3- Modbus Fixed Asynchronous Emulation	Pag.17
4.3.4- Asynchronous Emulation curves example	Pag.17
4.4- PID Closed Control Loop	Pag.18
4.4.1- Analog Ref. PID Closed Control Loop	Pag.18
4.4.2- Modbus Ref. PID Closed Control Loop	Pag.18
4.4.3- Modbus Fixed Ref. PID Closed Control Loop	Pag.19
4.4.4- Modbus Positive/Negative feedback	Pag.19
4.4.5- PID tuning procedure	Pag.19

5- ANALOG SIGNAL CONSIDERATION	Pag.21
6- OTHER FEATURES	Pag.22
6.1- Signal Parallel	Pag.22
6.2- Master and Slave	Pag.23
6.3- Filters Alarm	Pag.23
6.4- Soft Start	Pag.24
6.5- Speed Limitation	Pag.25
6.6- Power Limitation	Pag.25
6.7- Current Limitation	Pag.25
6.8- Motor Voltage	Pag.25
6.9- Bus Voltage monitoring	Pag.25
6.10- Fan Efficiency	Pag.25
6.11- Driver Overheating: DERATING	Pag.26
6.12- Motor Overheating: THERMAL PROTECTOR	Pag.26
6.13- Fan Noise	Pag.26
7- COMMUNICATION	Pag.27
7.0.1- Protocol interface:	Pag.27
7.0.2- Baud rate	Pag.27
7.0.3- Parity and Stop bits	Pag.27
7.0.4- Supported Function:	Pag.27
7.0.5- Modbus Communication Timeout	Pag.27
7.0.6- Modbus Address	Pag.27
7.0.7- Broadcast Address	Pag.27
7.1- Holding Register (Volatile)	Pag.27
7.2- Holding Register (Permanent)	Pag.28
7.3- Holding Registers Description	Pag.29
7.4- Input Register Description	Pag.33
7.5- Modbus USB-RS485 converter	Pag.35
7.6- OFFLINE Cable	Pag.35
7.7- Bluetooth Connection	Pag.35
8- ALARM HANDLING	Pag.36
8.0.1- Monitoring:	Pag.36
8.0.2- Modbus Registers - Alarm description:	Pag.36
8.0.3- Led Blinking - Alarm description:	Pag.37
8.0.4- Digital Output	Pag.37
9- AVAILABLE SOFTWARE	Pag.38

1- DEFINITIONS AND WARNINGS



For the purpose of this documentation and the product warning labels, "Warning" indicates that death, severe personal injury or substantial damage to property can result if proper precautions are not taken.



For the purpose of this documentation and the product warning labels, "Caution" indicates that minor personal injury or material damage can result if proper precautions are not taken.

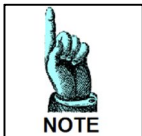

Note For the purpose of this documentation, "Note" indicates important information relating to the product or highlights part of the documentation for special attention.

1.0.1- Qualified personnel

For the purpose of this Instruction Manual and product labels, a "Qualified person" is someone who is familiar with the installation, mounting, start-up and operation of the equipment and the hazards involved. He or she must have the following qualifications:

- Trained and authorized to energize, de-energize, clear, ground and tag circuits and equipment in accordance with established safety procedures.
- Trained in the proper care and use of protective equipment in accordance with established safety procedures.
- Trained in rendering first aid.

1.0.2- Use for intended purpose only

The equipment may be used only for the application stated in the manual and only in conjunction with devices and components recommended and authorized by Nicotra Gebhardt.

1.1- Read carefully



Before installing and commissioning the DDMP fan, you must read all safety instructions and warnings carefully including all the warning labels attached to the equipment. Make sure that the warning labels are kept in a legible condition and replace missing or damaged labels.

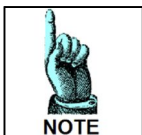

Nicotra || Gebhardt reserves the right to change without notice.

Information is also available from:

Nicotra Gebhardt S.p.A.
Via Modena, 18
24040 Ciserano Loc. Zingonia (BG)
Italy

Telephon: +39 035 873 111

Telefax: +39 035 884 319

E-mail: presales.italy@nicotra-gebhardt.com

1.2- Safety Instructions

The following warnings, cautions and notes are provided for your safety and as a means of preventing damage to the product or components at the connected machines. This section lists warnings, cautions and notes, which apply generally when handling the Nicotra Gebhardt Driver, classified as **General, Transport & Storage, Commissioning, Operation and Repair.**

Specific warnings, cautions and notes that apply to particular activities are listed at the beginning of the relevant chapters and are repeated or supplemented at critical points throughout these sections.

Please read the information carefully, since it is provided for your personal safety and will also help prolong the service life of your DDMP fan.

1.3- General



This equipment contains dangerous voltages and controls potentially dangerous rotating mechanical parts. Non-compliance with these warnings or failure to follow the instructions contained in this manual can result in loss of life, severe personal injury or serious damage to property.

Only suitable qualified personnel should work on this equipment, and only after becoming familiar with all safety notices, installation, operation and maintenance procedures contained in this manual. The successful and safe operation of this equipment is dependent upon its proper handling, installation, operation and maintenance.

Children and the general public must be prevented from accessing or approaching the equipment!

Risk of electric shock! The DC-BUS capacitors remain charged after mains supply has been switched off. It is not permissible to open the driver until 10 minutes after the mains supply has been removed.



This equipment may only be used for the purpose specified by the manufacturer. Unauthorized modifications and the use of spare parts and accessories that are not sold or recommended by the manufacturer of the equipment can cause fires, electric shocks and injuries.

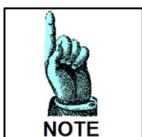

Keep these operating instructions within easy reach of the equipment and make them available to all users. Whenever measuring or testing has to be performed on live equipment suitable electronic tools should be used.

Before installing and commissioning, please read these safety instructions and warnings carefully and all the warning labels attached to the equipment.

Make sure that the warning labels are kept in a legible condition and replace missing or damaged labels.

1.4- Transport & Storage



Correct transport, storage, erection and mounting, as well as careful operation and maintenance are essential for proper and safe operation of the equipment.



Protect the DDMP fan against physical shocks and vibration during transport and storage. Also be sure to protect it against water (rainfall) and excessive temperatures.

1.5- Commissioning



Work on the device/system by unqualified personnel or failure to comply with warnings can result in severe personal injury or serious damage to material.

Only suitably qualified personnel trained in the setup, installation, commissioning and operation of the product should carry out work on the device/system.

This driver must be grounded.

The following terminals can carry dangerous voltages even if the Driver is inoperative:

- *the power supply terminals L, N*
- *the motor terminals U, V, W*

1.6- Operation



*The driver must NOT be removed from the related DDMP fan type and size.
The driver can't be used separate from the related fan.*



Ensure correct grounding connections. The ground cable must be sufficient to carry the maximum supply fault current which normally will be limited by the fuses or MCB. Suitably rated fuses or MCB should be fitted in the mains supply to the driver, according to any local legislation or codes.



The driver operates at high voltages.

Certain parameter settings may cause the driver to restart automatically after an input power failure.

1.7- Repair



Repairs on driver may only be carried out by Nicotra Gebhardt.

Before opening the driver for access, disconnect the power supply and wait for at least 10 minutes until the DC-BUS capacitor is completely discharged!

1.8- Declaration of conformity

The DDMP Driver product is conform to the relevant safety provisions of the Low Voltage Directive 2006/95/EC and the EMC Directive 2004/108/EC and has been designed and manufactured in accordance with the following harmonized European standards:

- **EN 61000-3-2 “Electromagnetic compatibility (EMC) - Part 3-2: Limits - Limits for harmonic current emissions (driver input current ≤ 16 A per phase)”.**
- **EN 61000-6-3 “Electromagnetic compatibility (EMC) - Part 6-3: Generic standards - Emission standard for residential, commercial and light-industrial environments”.**
- **EN 61000-6-4 “Electromagnetic compatibility (EMC) - Part 6-4: Generic standards - Emission standard for industrial environments”.**
- **EN 61800-3 EMC Product Standard for Power Drive Systems.**

1.8.1- Electromagnetic Compatibility

The DDMP product is designed with high standards of EMC in mind. The Driver, suitable for use within the European Union, is fitted with an internal EMC filter. This EMC filter is designed to reduce the conducted emissions back into the supply through the power cables for compliance with harmonized European standards. It is the responsibility of the installer to ensure that the equipment or system into which the product is incorporated complies with the EMC legislation of the country of use. Within the European Union, equipment into which this product is incorporated must comply with the EMC Directive 2004/108/EC.

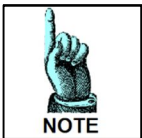

***To improve the Electromagnetic compatibility
A ferrites model Wurth 742 717 22
can be put on the power supply cable
(close to the driver).***

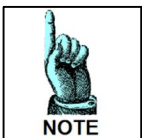

***The compliancy to the standards are intended for a single fan.
No tests have been made on multiple installations.***

2- PRODUCT OVERVIEW

2.0.1- General Information

The DDMP is a forward curved blade fan equipped by an external permanent magnet rotor motor. The rotor magnets are made by rare earths (NdFeB) that strongly reduce the motor dimension and therefore the fan obstruction. The motor shape itself has been chosen for increasing the airflow inside the fan scroll.

The Driver is compact and it's directly installed on board of the fan. It is equipped with an active PFC (Power Factor > 0.95 in any state of operation) and it drives the motor through a sensorless algorithm.



This manual refers to DDMP fans equipped with drivers having a firmware Revision 5 or higher

2.0.2- 1kW Driver

In the following figures is shown the 1kW Driver and its parts.



Fig. 1 – DDMP 1kW Driver front and side view



Fig. 2 – DDMP 1kW Driver – Complete view

2.0.3- 2kW Driver

In the following figures is shown the 2kW Driver and its parts.



Fig. 3– DDMP 2kW Driver front and side view



Fig. 4 – DDMP 2kW Driver – POWER BOARD and CONTROL BOARD

2.0.4- Features

- Supply voltage 220V-240V +/-10% (50/60Hz)
- Sinusoidal Sensorless control
- Integrated active Power Factor Controller
- Simple cable connection with cage clamps
- Integrated Modbus RTU interface
- Integrated analogue interface 0-10V
- Tachometric output available

2.0.5- Performance

- Constant Airflow Sensorless function
- Asynchronous Mode Emulation
- Internal PID available
- Soft start
- Adjustable limits and operating mode
- Self-protecting strategies implemented
- High efficiency
- NTC bypassed during operation
- PFC disabled at stop
- 1.1 kW and 2.1 kW maximum input power
- Power Factor >0.95

2.0.6- Protection

- Missing phase protection
- Short circuit protection
- Overload protection
- Overheat protection
- Impeller blocking protection
- Safe Operating Area (speed, power and current limitation)

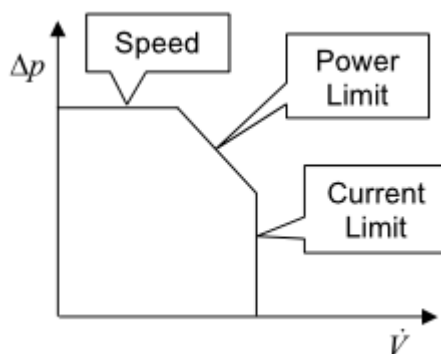

Fig. 5 – Safe Operating Area

2.0.7- Ambient Operating Conditions

- Protection Class: IP 44
- Humidity Range: 90% non-condensing
- Altitude: if the fan is to be installed at an altitude > 1000m, derating is required.
- Shocks: do not drop the fan or expose it to sudden shock.
- Vibration: do not install the fan in an area where it is likely to be exposed to constant vibrations.

3- CONNECTIONS



Work on the driver/fan by unqualified personnel or failure to comply with warnings can result in severe personal injury or serious damage to material.

Only suitably qualified personnel trained in the set-up, installation, commissioning and operation of the product should carry out work on the driver/fan. This driver must be grounded. The following terminals can carry dangerous voltages even if the driver is inoperative:

- the power supply terminals L, N
- the motor terminals U, V, W

The DDMP driver connections are shown in figure 6 (1kW driver) and 7 (2kW driver).

- The motor is already connected to the driver by the operators Nicotra | Gebhardt
- The end user have to connect the power supply cable
- The end user have to connect the command signal to the control board

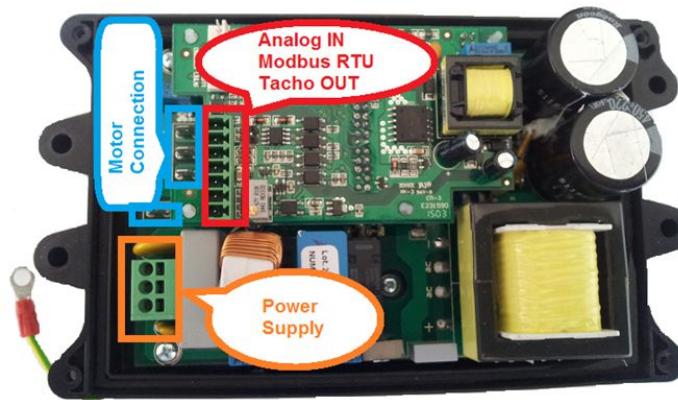

Fig. 6 – 1kW Driver connection terminals

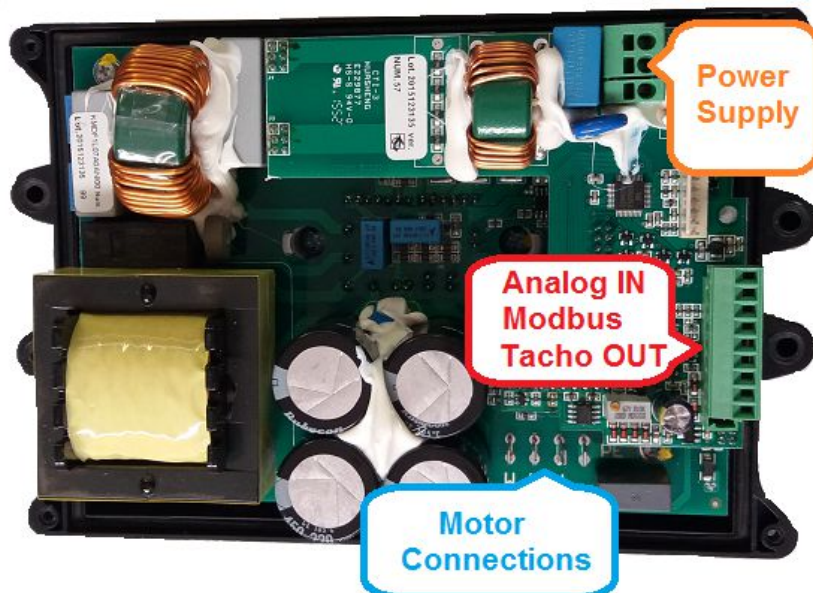

Fig. 7 – 2kW Driver connection terminals



The grounding cable/metal strip connecting the Driver to the side plate of the driver must not be disconnected.

3.0.1- Power supply connection:

Single Phase 220/240V $\pm 10\%$ @ 50/60Hz (Fig. 8)

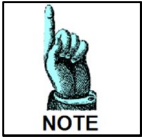

The performance in the range [200V-264V] @ 50Hz/60Hz is always the same due to the PFC module inside the driver!

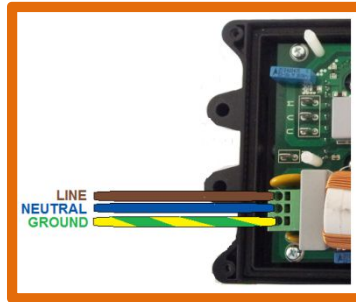

Fig. 8 – Driver – POWER SUPPLY connection

3.0.2- Control Board connection:

As default the Driver is programmed for an analog input command of 0-10V (Fig. 9). The analog input can accept also a PWM signal with $f > 1\text{kHz}$.

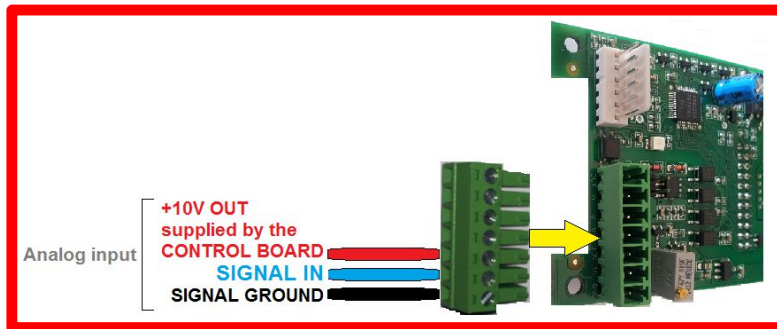

Fig. 9 – Driver – CONTROL BOARD analog connection

In figure 10 is shown the Modbus connection diagram.

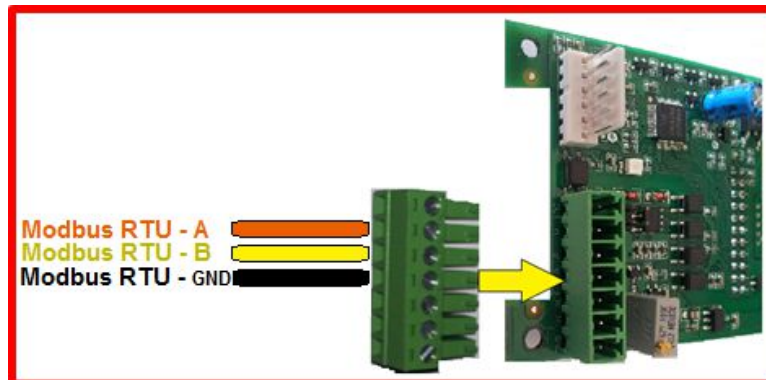

Fig.10 – Driver – CONTROL BOARD Modbus connection



Don't use devices having the signal GND connected to the NEUTRAL cable of the power supply. The driver may be damaged or not functioning properly.



The 2kW driver has two terminal more for a power supply of +12V. This is intended to be used for small cooling fan for special applications (Fig. 11) the max current out must be less than 200mA. It is NOT required for std. DDMP application.



Fig.11

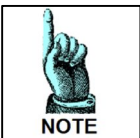

To set the speed through the Modbus protocol is necessary to set a dedicated register (Input Type – HOLDING REGISTER 34 see “ Modbus communication” paragraph)

In figure 12 is shown how to connect the tachometric output.

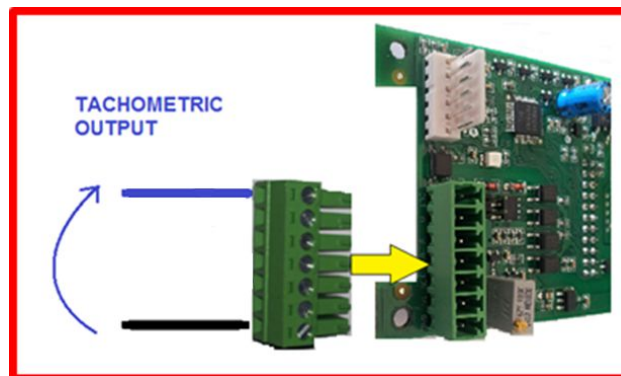
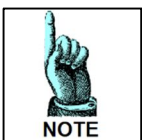

Fig.12 – Driver – CONTROL BOARD tachometric output connection

The tachometric output is a 0 to 5V PWM waveform at 1KHz with the following duty cycle:

$$Duty\ Cycle\ (Speed) = \begin{cases} 0\% & 0 \leq Speed < Speed_{min} \\ 10\% + \frac{90\% \cdot (Speed_{Real} - Speed_{min})}{Speed_{MAX} - Speed_{min}} & Speed \geq Speed_{min} \end{cases}$$



Remember that the $Speed_{Real}$ is 0 below $Speed_{min}$



The +10V power supply available of the Driver is intended to be used with a potentiometer of minimum 2KOhm.

Any different devices connected to it could bring to an undesired functioning of the Driver or the connected device. The absorbed current must be <5mA.



Don't reverse the input signal or connect the +10V to signal ground. The Driver could be damaged.

Don't apply signals with voltage higher than 10V. The Driver could be damaged.

4- OPERATING MODES

The DDMP fan has 4 possible **Operating Modes**:

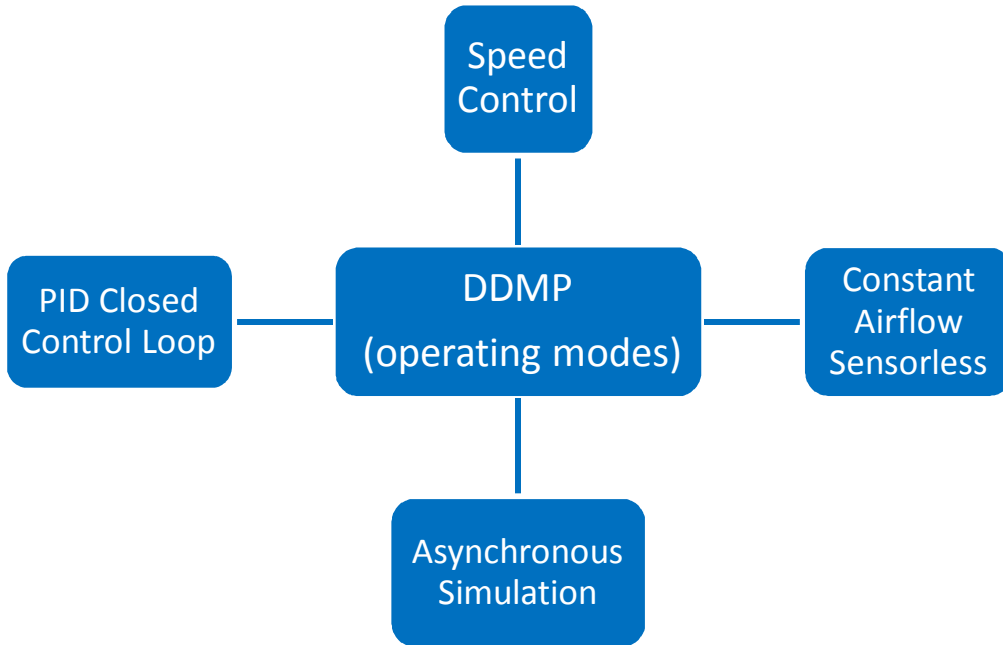

Fig.13

For each mode there are 3 possible **Setting Options**:

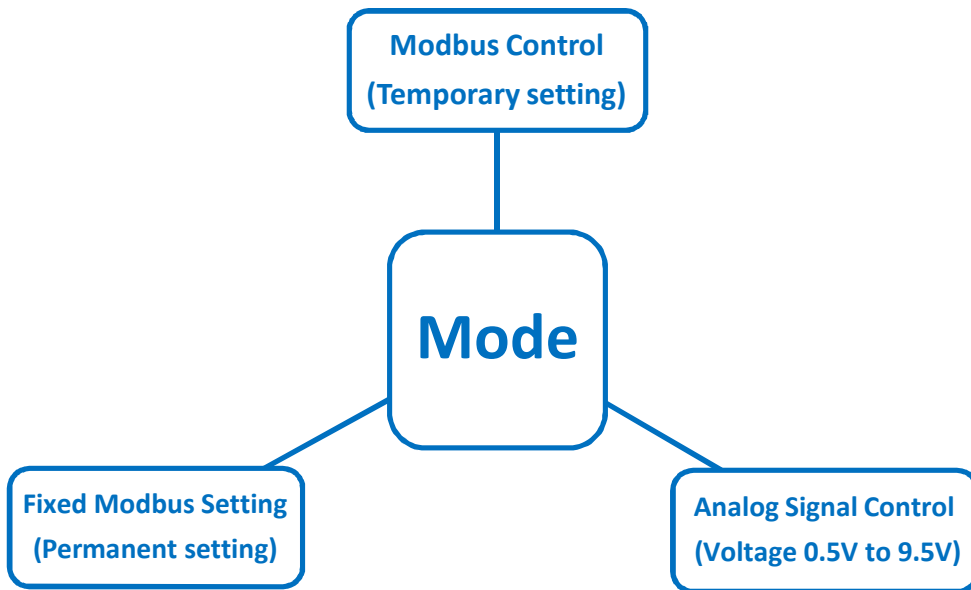

Fig.14

The operating modes and the setting options can be chosen by modifying the INPUT TYPE [Holding Register 34](#)

4.1- Speed Control

4.1.1- Analog Speed Control (INPUT TYPE = 1 Default factory setting)

Through this setting the fan speed is proportional to the analog voltage input fig. 15. The fan speed is limited by the Safe Operating Area(see Fig. 5 Page 8) therefore, depending on the fan working point, the fan could be no more able to increase the speed coherently to the set voltage value.

To avoid the loss of signal dynamic, it is necessary a speed limits rescaling by modifying the value of the Max Speed Holding Register 2. It is also possible to rescale the min Speed by modifying the Holding Register 1.

The analog signal can be read from the Input Register 14.

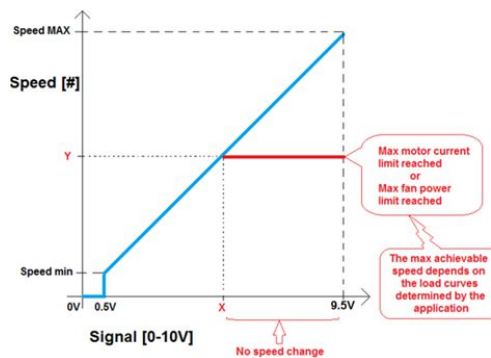

Fig.15 – Analog signal-Speed relationship.

The MAX and min speed default values are in function of the fan sizes .

4.1.2- Modbus Speed Control (INPUT TYPE = 0)

Through this setting the fan runs at the speed defined by modifying the Holding Register 66.

The setting is maintained meanwhile the fan is powered on and it is lost when the fan is powered off.

4.1.3- Modbus Fixed Speed Control (INPUT TYPE = 2)

Through this setting the fan runs at the speed defined by modifying the Holding Register 21.

The setting is permanent and fan starts at the defined speed each time it is powered on.

4.1.4- Speed Control curves example

In figure 16 it is shown a set of performance curves at different speed settings limited by the fan max working limit curve (see Safe Operating Area)

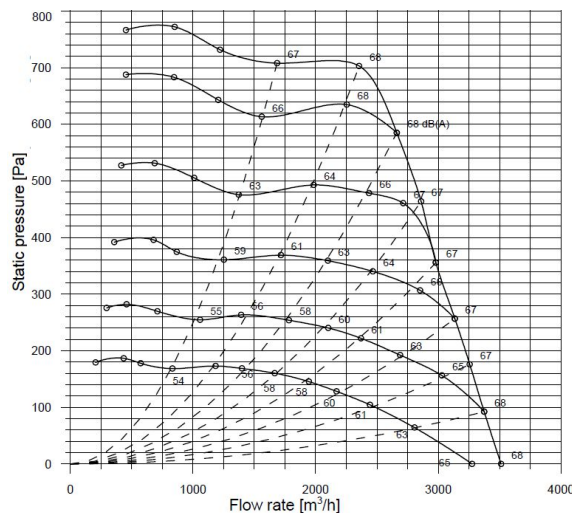

Fig.16 – Speed control curves - PERFORMANCE

While in figure 17 it is shown the speed in function of the Airflow

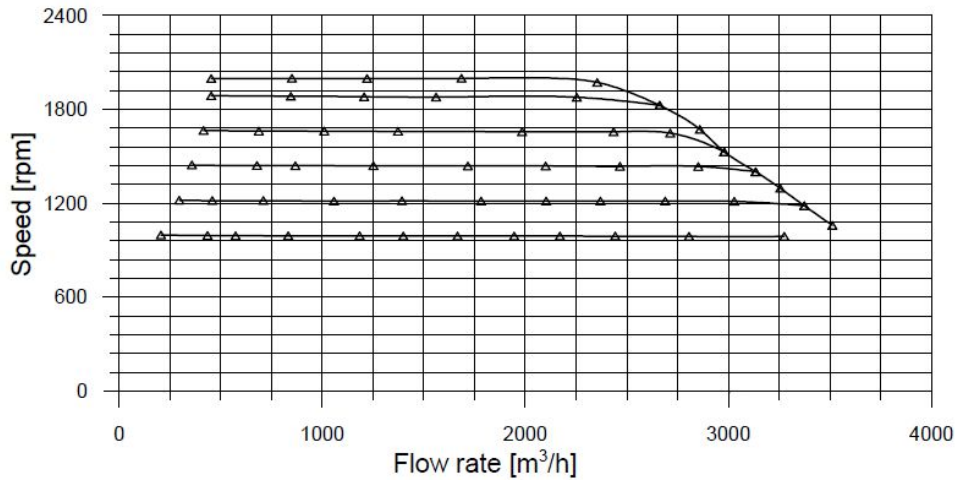
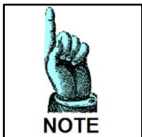

Fig.17 – Speed control curves – SPEED

4.2- Constant Airflow

Through this mode a Constant Airflow is maintained without any external pressure transducer. This is obtained through a dedicated algorithm loaded into the microcontroller of the driver.



The driver microcontroller elaborates only speed and current data to obtain the constant performance, but it is completely blind the airflow and static pressure value. Therefore these values are not available in the driver Input Registers.

4.2.1- Analog Constant Airflow (INPUT TYPE = 4)

Through this setting the constant airflow is proportional to the analog voltage input and the relationship is shown in fig. 18.

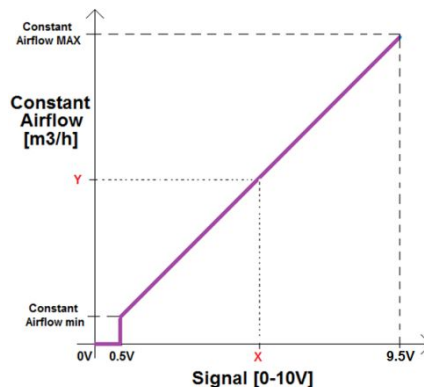
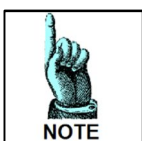

Fig. 18 – Analog Signal-Constant Airflow relationship

The selectable airflows are restricted to a defined range for each fan size. The lower limit avoid big deviations on the constant airflow while the high limits are determined by the Safe Operating Area.



*The max resolution from on constant airflow to another is +/-50m³/h.
The max precision guaranteed is SET AIRFLOW +/- 100 m³/h
In the instability areas typical of some fan sizes the constant airflow precision can't be guaranteed. It's anyway suggested to work outside these areas.*

4.2.2- Modbus Constant Airflow (INPUT TYPE = 5)

Through this setting the fan runs at the constant airflow defined by modifying the Holding Register 66. The setting is maintained meanwhile the fan is powered on and it is lost when the fan is powered off.

4.2.3- Modbus Fixed Constant Airflow (INPUT TYPE = 6)

Through this setting the fan runs at the constant airflow defined by modifying the Holding Register 39. The setting is permanent and fan starts at the defined constant airflow each time it is powered on.

4.2.4- Constant Airflow curves example

In figure 19 are shown 6 constant airflow curves randomly chosen. Each fan has default lower limit for the constant airflow curves that can be increased by modifying the Holding Register 42 and a default higher limit that can be decreased by modifying the Holding Register 43.

The choice of reducing the Constant Airflow Range is depending on the user application and it is especially useful when the application must guarantee a defined minimum constant airflow.

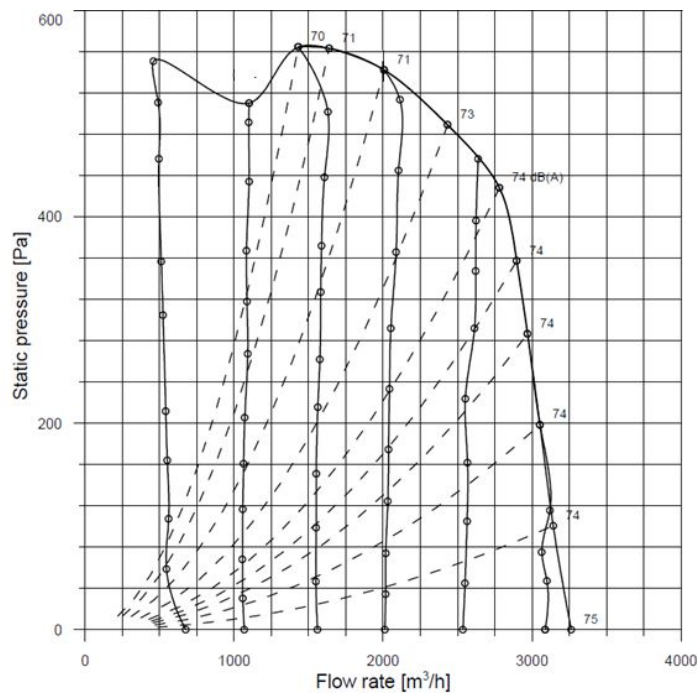

Fig.19 – Constant Airflow curves - PERFORMANCE

While in figure 20 it is shown the speed in function of the Airflow of each constant airflow.

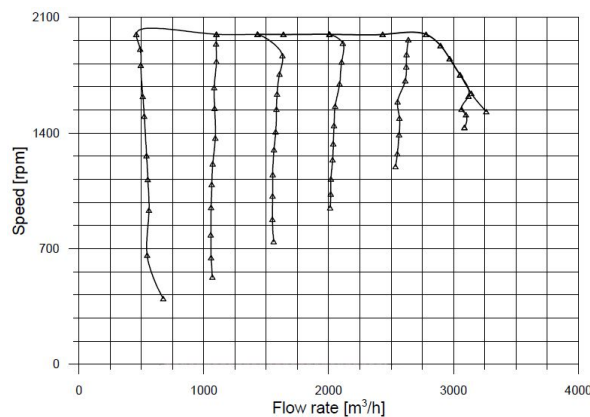

Fig.20 – Speed control curves - SPEED

4.3- Asynchronous Emulation

Through this mode there is the possibility to emulate the behavior of an asynchronous induction motor with a slip and a power limitation dependent on the load and speed (therefore there could be some differences from each size).

The control is expressed in percentage instead of a defined measure of unit. The lower is the slip the higher is the performance and vice versa.

4.3.1- Analog Asynchronous Emulation (**INPUT TYPE = 7**)

Through this setting the slip is proportional to the analog voltage input and the relationship is shown in fig. 21.

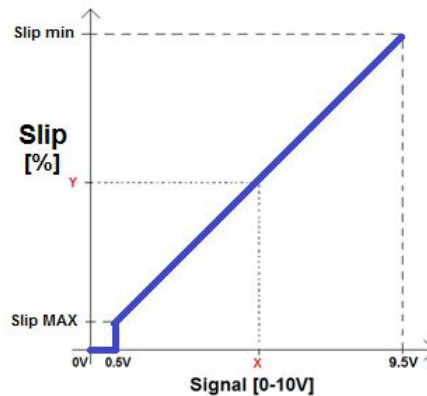

Fig. 21 – Analog Signal-Asynchronous Emulation relationship

4.3.2- Modbus Asynchronous Emulation (**INPUT TYPE = 8**)

Through this setting the fan emulate an ACIM motor and the slip is defined by modifying the [Holding Register 66](#). The setting is maintained meanwhile the fan is powered on and it is lost when the fan is powered off.

4.3.3- Modbus Fixed Asynchronous Emulation (**INPUT TYPE = 9**)

Through this setting the fan emulate an ACIM motor and the slip is defined by modifying the [Holding Register 30](#). The setting is permanent and fan starts at the defined constant slip each time it is powered on.

4.3.4- Asynchronous Emulation curves example

In figure 22 are shown 5 curves with the following slip percentage: 100%, 80%, 60%, 40% and 20%

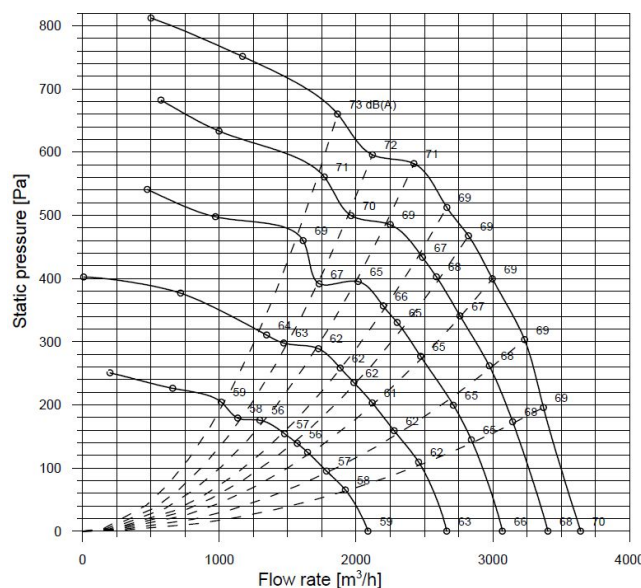

Fig.22 – Asynchronous Emulation curves - PERFORMANCE

While in figure 23 it is shown the speed in function of the Airflow of each asynchronous emulated curve.

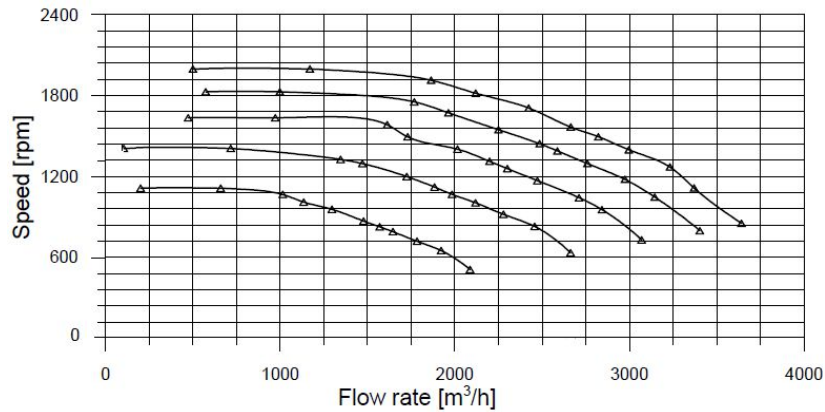

Fig.23 – Asynchronous Emulation curves – SPEED

4.4- PID Closed Control Loop

Through this setting the fan is able to work in a PID closed control loop where the measured process variable is connected to the analog input and it must be in the range of [0,10V]

The PID mode can be therefore used with temperature probes, pressure transducer, CO/CO₂ detectors, etc.

The parameters to set are:

- K_p = Proportional Gain Holding Register 51
- K_I = Integral Gain Holding Register 52
- K_D = Derivative Gain Holding Register 53
- $Time = T_{PID}$ Holding Register 54

Here in the following the simplified PID code:

$$Error = (R_{reference} - M_{easure});$$

$$P_{roportional} = K_p \cdot Error;$$

$$I_{ntegral} + = K_I \cdot Error \cdot T_{PID};$$

$$D_{erivative} = \frac{K_D (Error_n - Error_{n-1})}{T_{PID}};$$

$$Error_{n-1} = Error_n;$$

$$R_{esult} = P_{roportional} + I_{ntegral} + D_{erivative};$$

4.4.1- Analog Ref. PID Closed Control Loop (INPUT TYPE = 10)

This mode is not available on DDMP fans because there is only one analog input.

4.4.2- Modbus Ref. PID Closed Control Loop (INPUT TYPE = 11)

Through this mode the PID reference is defined by modifying the Holding Register 66.

The value of the reference is expressed in steps of 0.1Volt (therefore the register rages from 0 to 100)

The PID error is calculated in the following way:

$$Error = (Modbus_{REG_66} - ANALOG_{Input})$$

4.4.3- Modbus Fixed Ref. PID Closed Control Loop (**INPUT TYPE = 12**)

Through this mode the PID reference is defined by modifying the **Holding Register 50**.

The value of the reference is expressed in units of 0.1Volt (therefore the register ranges from 0 to 100)

The PID error is calculated in the following way:

$$Error = (Modbus_{REG_50} - ANALOG_{Input})$$

4.4.4- Modbus Positive/Negative feedback

Depending on the application it could be necessary to invert the feedback behavior (Fig.24).

Through the **Holding Register 31** it is possible to multiply by -1 the PID error.

When the register is set to 0 $\rightarrow Error = (R_{eference} - M_{easure})$;

When the register is set to 1 $\rightarrow Error = (M_{easure} - R_{eference})$;

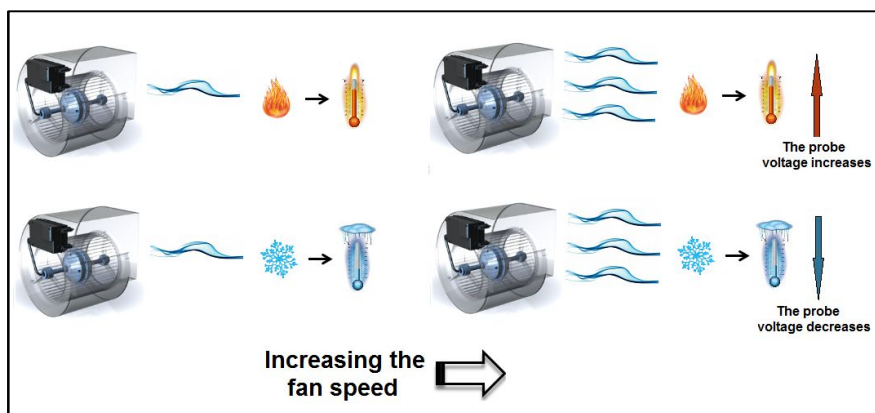

Fig. 24 – Example of positive/negative feedback coefficient

4.4.5- PID tuning procedure

In this paragraph are described some fast rules to set the PID parameters.

(Here it is described the closed loop Ziegler-Nichols method)

- 1) Set the parameter $Time = T_{PID}$ as a trade-off between:
 - a. Fast speed of response (which are favored by a small value of T_{PID})
 - b. Stability and robustness (which are favored by a large value of T_{PID})

The time must be higher than the delay of the fan $T_{PID} > \tau_{fan}$ and higher than the delay of the transducer connected to the fan $T_{PID} > \tau_{transducer}$.

The deceleration/acceleration ramp of the DDMP can be read in the fig. 46 and considering an average value of 200 rpm/s the T_{PID} can be chosen starting from 5ms.

- 2) Rescale the max speed register basing on the limitation occurring in the final application or eventually verify the max voltage signal out form the transducer at the max fan speed.
- 3) In open loop set the fan speed at the desired performance and read the transducer voltage value (Fig.25)

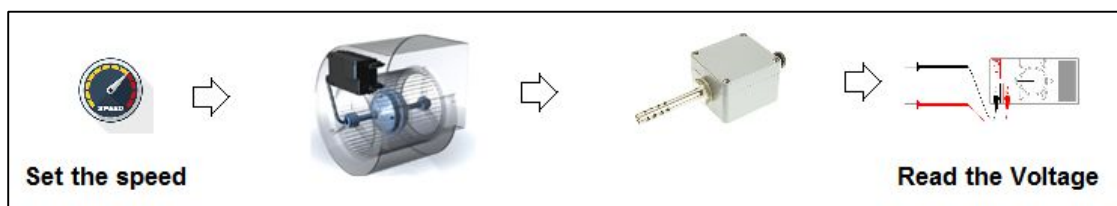

Fig. 25 – Find the PID Reference

- 4) Increase the $K_p = K_{osc}$ gain until the system starts oscillating. In fig. 26 the red line is the reference and the blue line is the transducer voltage value.

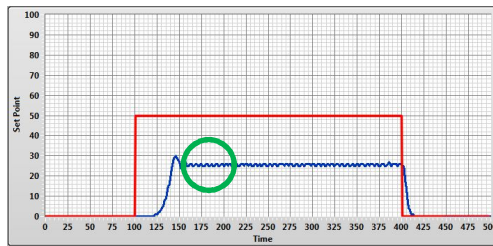

Fig. 26 – Oscillating System

- 5) Measure the oscillation N_{osc} occurring in $X_{Seconds}$ as shown in fig 27 (X can be chosen at random).

Considering that $T_{osc} = \frac{X_{Seconds}}{N_{osc}}$

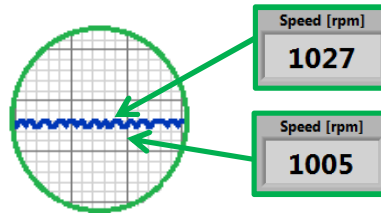

Fig. 27 – Measure of the oscillations

- 6) Find the K_p, K_I and K_D using the table of fig 28 and considering that $T_I = \frac{K_p}{K_I}$ and $T_D = \frac{K_D}{K_p}$:

	K_p	T_I	T_D
Regulator P	$0.5 \cdot K_{osc}$		
Regulator PI	$0.45 \cdot K_{osc}$	$\frac{T_{osc}}{1.2}$	
Regulator PID	$0.6 \cdot K_{osc}$	$\frac{T_{osc}}{2}$	$\frac{T_{osc}}{8}$

Fig. 28 – Table of gains

In the figure 29 is shown the behavior of the PID regulator with 3 different T_{PID}

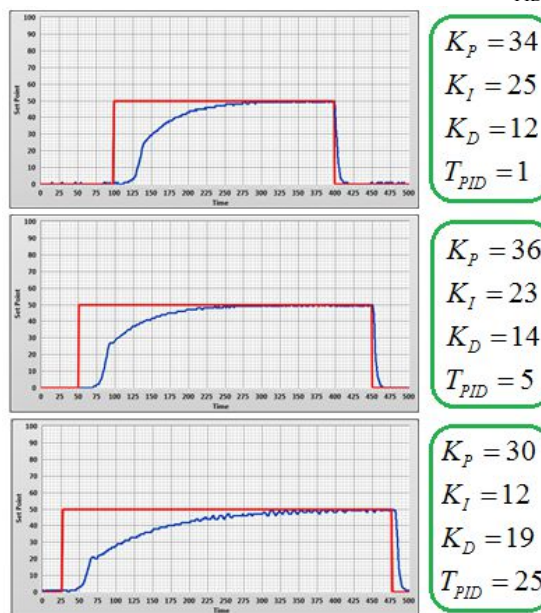

Fig. 29 – PID with 3 different T_{PID} values

5- ANALOG SIGNAL CONSIDERATION

In this paragraph is shown the way for finding the V_{req} (voltage required) for achieving the $Speed_{Desired}$ using the diagram Sig./Speed (fig.30)

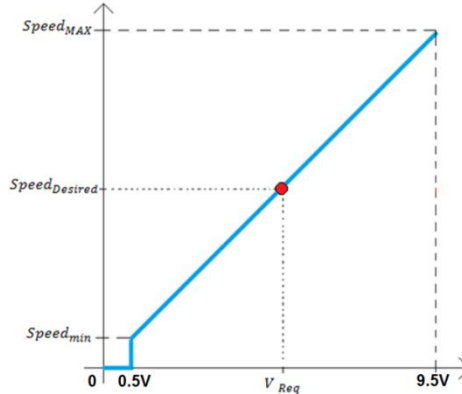

Fig.30 – Analog Signal

$$V_{req} = \frac{Speed_{Desired} - Speed_{min}}{Speed_{MAX} - Speed_{min}} \cdot 9V + 0.5V$$

$$PotentiometerValue = Pot_{Val} = R_1 + R_2 \geq 2K\Omega$$

$$Input_{IMPEDANCE} = 20K\Omega$$

$$V_{req} = \frac{200K\Omega \cdot R_2}{Pot_{Val} \cdot (20K\Omega + R_2) - R_2^2} \quad \text{while with N fan in parallel} \quad V_{req} = \frac{200K\Omega \cdot R_2}{Pot_{Val} \cdot (20K\Omega + NR_2) - NR_2^2}$$

$$\text{Therefore } R_2 = \frac{Pot_{Val} \cdot V_{req} - 200K\Omega + \sqrt{(200K\Omega - V_{req} \cdot Pot_{Val})^2 + 80K\Omega \cdot V_{req}^2 \cdot Pot_{Val}}}{2 \cdot V_{req}}$$

In figure 31 is shown the behavior of the analog voltage signal increasing the potentiometer value and the behavior increasing the number of fans in parallel.

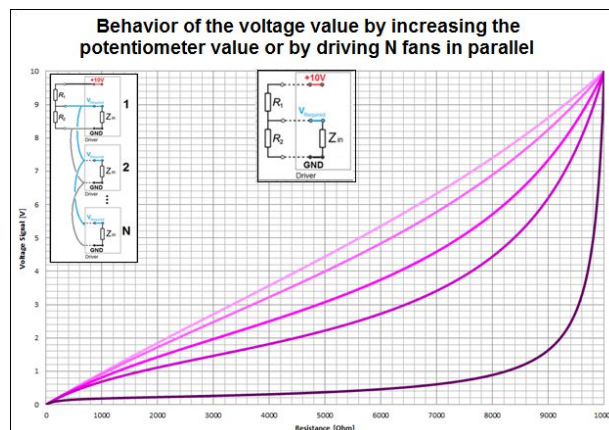

Fig.31 – Analog voltage behavior increasing the potentiometer value or increasing the fan in parallel

The final result for the user is an higher sensibility of the command for small changes of the potentiometer position.

6- OTHER FEATURES

The DDMP has several **Other Features** as shown in fig.32.

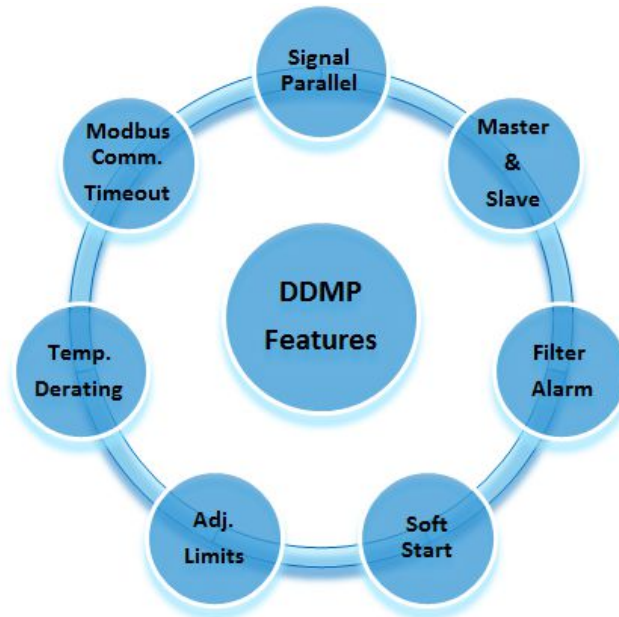

Fig.32

6.1- Signal Parallel

If two or more fans are installed in the same compartment it is important that they start at the same time, otherwise the first fan running forces the other to run in backward rotation. The DDMP fans are able to start with a low backward rotation (speed < 200rpm), but they stops if the backward rotation is higher due to the built-in auto-protection feature. With the signal parallel this problem can be avoided (Fig. 33)

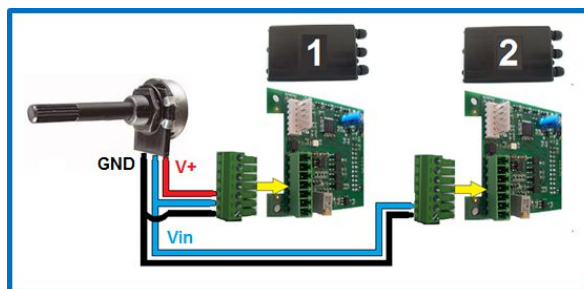

Fig. 33 – SPEED CONTROL - PARALLEL Connection

Nicotra||Gebhardt can supply a dedicated potentiometer: REGPOT code K43138 In figure 34 is shown the connection diagrams (with stop function o without).

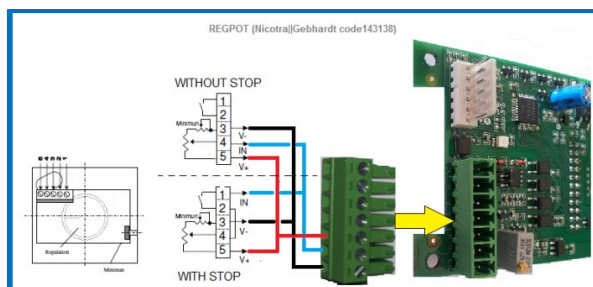

Fig. 34 – Nicotra || Gebhardt potentiometer –REGPOT

6.2- Master and Slave

It is possible to drive two fans in a master and slave configuration by setting the MASTER in one preferred mode and the SLAVE in Speed Control mode only.

The SLAVE operating mode must be changed (**INPUT TYPE = 3**)

The MASTER must have the **Holding Register 46** set at 0 = TACHO.

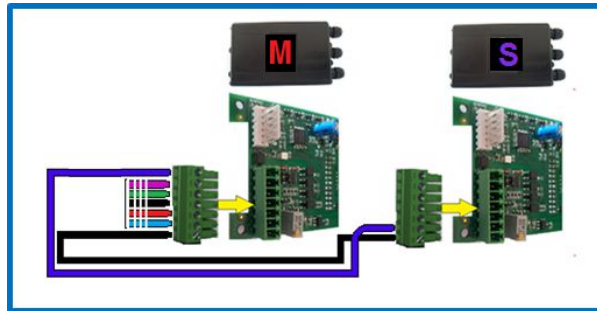

Fig. 35 – MASTER/SLAVE connection

This function is recommended for example when two fans work in the same plenum in constant airflow mode. Otherwise if the fans are set both in constant airflow mode driven by the same analog signal, the two close control loops interfere each other.

6.3- Filters Alarm

This feature is interesting when used in Constant Airflow or in Asynchronous emulation (see figures 36 and 37). When the filters become dirty in the two previous mode the fan speed increases, therefore a speed threshold can be used to identify this situation.

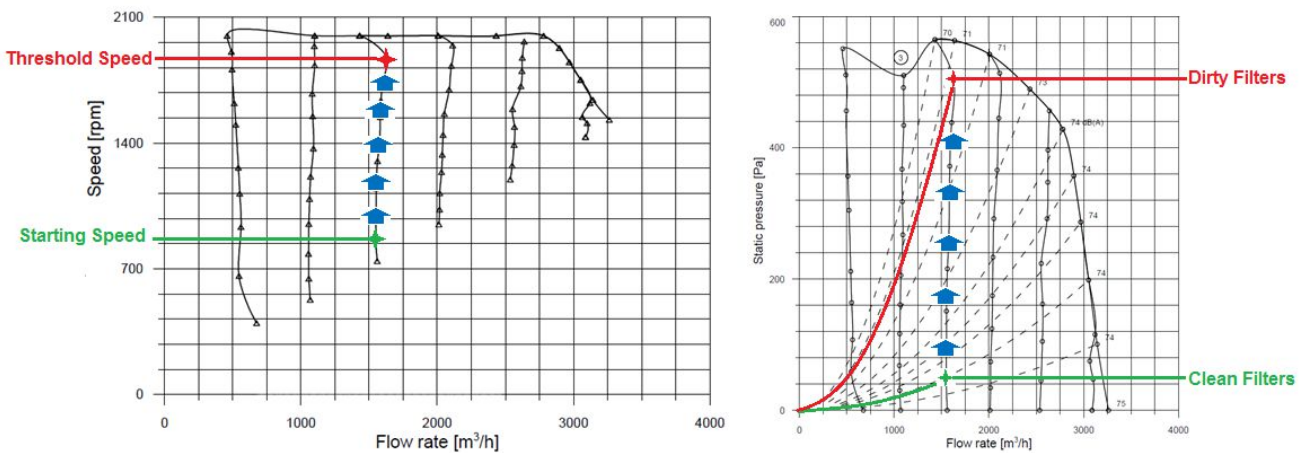

Fig. 36 – Constant Airflow - FILTERS DIRTY

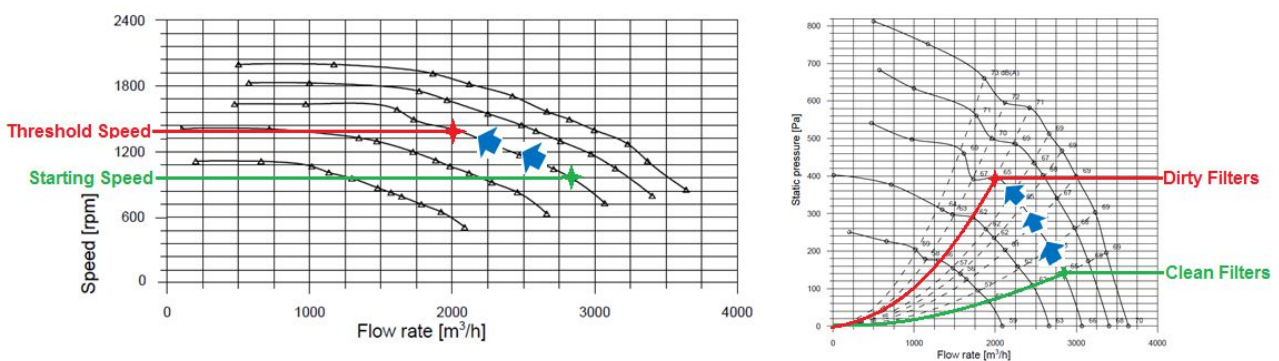

Fig. 37 – Asynchronous emulation - FILTERS DIRTY

To activate this feature the [Holding Register 46](#) must be set at value 2 and then the required Speed Threshold value must be set into the [Holding Register 55](#).

The digital output of the driver changes its status as shown in the fig 38.

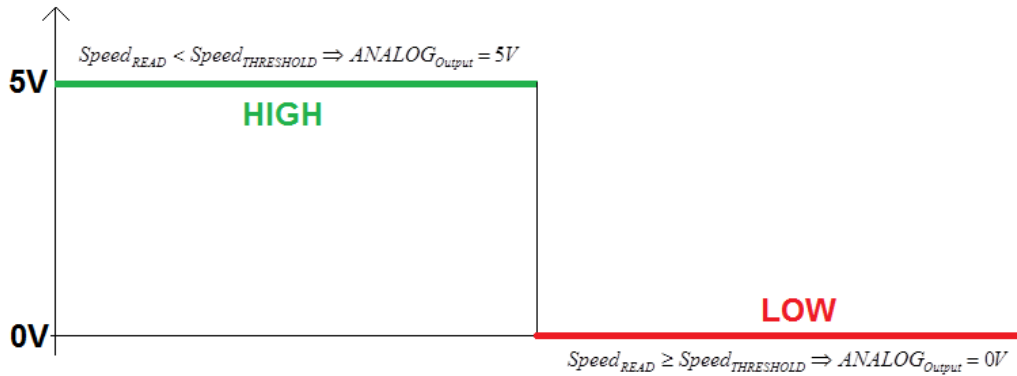

Fig. 38 – Threshold Speed - Analog Output behavior

6.4- Soft Start

In the following paragraph it is shown the starting phase of a DDMP fan.

- The first phase when the fan receives a command to start running is the ALIGNMENT. During this phase the driver aligns the rotor. (If there is a cause making the fan rotating in the opposite direction with a speed lower than 200rpm, the fan is actually able to brake the wheel and proceed with the alignment) This phase takes 1 second.
- The second phase is the dragging phase, where the fan gradually increases its speed to the minimum in open loop. In this phase the current and speed values present in the Input Register can't be taken in consideration. This phase takes 8 seconds.
- The last phase is the closed loop where the sensorless control is active and from the minimum speed to the target speed the fan accelerates with different ramps basing on the fan size and the wheel inertia. The acceleration and deceleration values are different and in particular to avoid overvoltage alarm or loss of synchronism alarm, the deceleration is always lower.

The [Input Register 2](#) indicates the Speed Reference (minimum speed during alignment and dragging and the Set Speed in Closed Control Loop)

The [Input Register 3](#) indicates the Measured Speed.

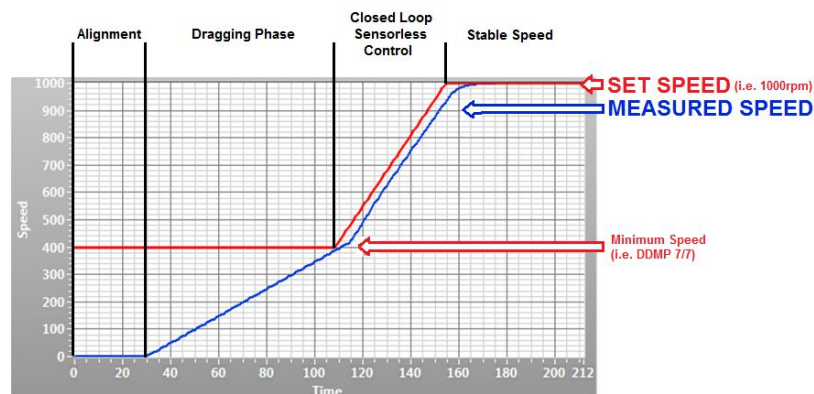

Fig. 39 – Starting phase of a DDMP

6.5- Speed Limitation

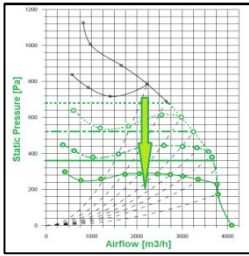

Fig. 40

The speed limits can be adjusted for the signal rescaling as explained in the paragraph 4.1, but also to limit the noise in the final application.

In figure 40 it is shown the performance reduction when the power limitation is decreased.

6.6- Power Limitation

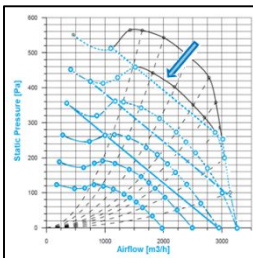

Fig. 41

The DDMP Drivers are set by factory default to the max achievable power out to the motor that is 1.05kW and 2.1kW for the two versions respectively.

During the functioning it is possible to monitor the instant power absorption by reading the [Input Register 32](#). If for some application it is necessary to keep the absorption of the fan below a defined power value, it is possible to reduce the max power out by modifying the [Holding Register 36](#). In figure 41 it is shown the performance reduction when the power limitation is decreased.

6.7- Current Limitation

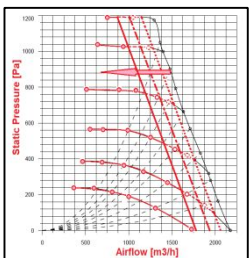

Fig. 42

The DDMP Drivers are set by factory default to the max peak motor current out that changes depending on the motor windings characteristics.

During the functioning it is possible to read the peak motor current to the motor by reading the [Input Register 12](#). It is possible to reduce the motor current by modifying the [Holding Register 7](#). It is suggested to keep the motor current above the 2000mA for the 1kW DDMP models and 5500mA for the 2kW DDMP models.

In figure 42 it is shown the performance reduction when the power limitation is decreased.

6.8- Motor Voltage

To complete the motor parameters overview it is possible to read the voltage out by reading the [Input Register 13](#)

6.9- Bus Voltage monitoring

The PFC inside the driver increases the rectified input voltage up to 380V for the 1kW version and 400V for the 2kW version.

The Bus Voltage value can be monitored by reading the [Input Register 9](#).

6.10- Fan Efficiency

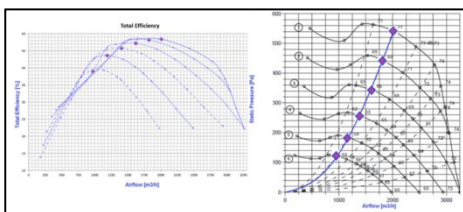

Fig.43 – DDMP Total Efficiency

All the DDMP range is compliant to the ErP requirements.

In figure 43 it is shown the efficiency in function of the airflow at several different speeds.

6.11- Driver Overheating: DERATING

When the temperature of the Driver components overtakes a fixed threshold of 75°C the Driver automatically reduces the performance in order to decrease the heating. It is possible to check in real time the driver temperature by reading the [Input Register 15](#)

If it is not possible to reach a steady thermal equilibrium, the Driver shuts down. The protection acts limiting the current to the motor .

In this condition the driver goes in alarm (see the Alarm Handling chapter)

Once the temperature on the driver decreases under 75°C the driver automatically reset the alarm and it restarts functioning.

6.12- Motor Overheating: THERMAL PROTECTOR

The motor is protected through a Thermal Protector.

If the motor temperature is too high the thermal protector opens one phase and the Driver recognizes the error and it stops the fan (see the Alarm Handling chapter).

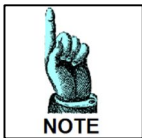

***The Motor Winding temperature and the Driver derating are dependent on the fan size and on the fan working point.
Therefore it is possible that the fan could work at 50°C without a performance limitation***

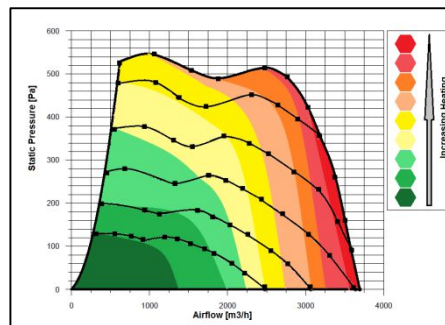

Fig.44 – DDMP thermal behavior



***The Driver and motor areas rated for operating in a temperature range between -20°C and +40°C. The derating is tested and guaranteed from +40°C to +50°C .
Higher temperatures could damage the motor winding or the performance could be strongly reduced.***

6.13- Fan Noise

In figure 45 is shown the indicative distribution of the Sound Pressure Level of a DDMP model .

The DDMP fans can reach high speed compared to the std. AC fans, therefore it's important to evaluate the speed at the required performance to avoid noise problems

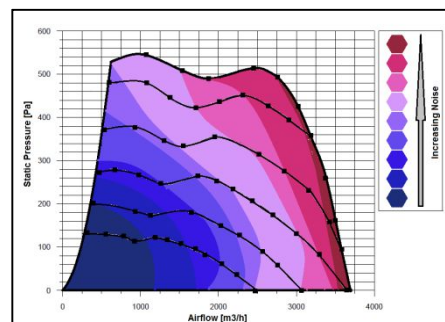

Fig.45 – DDMP Noise distribution – Sound Pressure Level

7- COMMUNICATION

7.0.1- Protocol interface:

MODBUS RTU (RS485 or Bluetooth)

7.0.2- Baud rate

The baud rate can be set through the Holding Register 47 and the possible speed are:

Modbus RTU: 9.6kbps and 19.2kbps (higher speed are not allowed due to the board Opto-Insulators)

Bluetooth: 9.6kbps, 19.2kbps, 38.4kbps and 57.6kbps.

7.0.3- Parity and Stop bits

The parity and the stop bits can be chosen by modifying the Holding Register 48 and the possible choices are:

- 0 = No parity, 2 stop bits (Default)
- 1 = Odd parity, 1 stop bit
- 2 = Even parity, 1 stop bit

7.0.4- Supported Function:

- 03 – Read Holding Register
- 04 – Read Input Register
- 06 – Write Single Holding Register
- 16 – Write Multiple Holding Register

7.0.5- Modbus Communication Timeout

With this feature is possible to stop the fan when the communication is lost, after a period of time set in the Holding Register 56. The register can be set to:

- 0 – No Communication Timeout
- 1 to 32767 – time expressed in second, therefore it is possible to set from 1sec to 9h 6m 8 sec.

When the timeout occurs the driver goes in alarm condition and the communication must be restored and the alarm must be cleared.

The alarm is indicated in the Input register 17 with the value of 255 (0xFF).

7.0.6- Modbus Address

The slave device address can be changed from value 1 to 247 by modifying the Holding Register 45.

7.0.7- Broadcast Address

The Broadcast address is 0. The default address from factory configuring is 1.

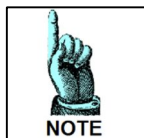

To make the Modbus changing effective the driver must be powered off and power on again.

7.1- Holding Register (Volatile)

The Holding Register 66 is a special register used in each operating mode for setting the speed, the airflow, the slip and the PID reference.

It is not a physical register and it can be written, but it is not possible to read its value.

The setting remains active meanwhile the fan is powered on.

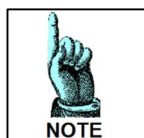

If the fan is powered off but there is a residual charge, the microcontroller of the driver is still functioning. Therefore if is powered on in this situation the value set through the register 66 is still active.

7.2- Holding Register (Permanent)

The physical DDMP Holding Registers are 64 and in fig.46 is shown the description and the parameters loaded into the fan models as factory default.

Only green registers can be written by the final user, while the others are covered by password and can be modified only by Nicotra | Gebhardt technicians.

REG	Description	DDMP 7/7 Tight 1kW	DDMP 7/7 1kW	DDMP 7/9 1kW	DDMP 8/7 Tight 1kW	DDMP 9/7 1kW	DDMP 8/9 Tight 1kW	DDMP 225/240 1kW	DDMP 9/9 1kW	DDMP 10/8 1kW	DDMP 10/10 1kW	DDMP 9/9 2kW	DDMP 10/8 2kW	DDMP 10/10 2kW	DDMP 12/9 2kW	DDMP 12/12 2kW
0	Reset	0	0	0	0	0	0	0	0	0	0	0	0	0	0	0
1	Min Speed	400	400	400	400	400	400	400	400	400	400	300	300	300	300	300
2	Max Speed	3000	2000	2000	2000	2000	2000	2000	2000	2000	2000	2000	2000	2000	1600	1600
3	Acceleration	300	300	300	300	300	300	300	300	300	300	200	200	200	200	200
4	Deceleration	150	150	100	100	100	100	100	100	80	80	80	80	80	60	60
5	Pole Couples	4	4	4	4	4	4	4	4	4	4	4	4	4	4	4
6	Startup Current	2000	2000	2000	2000	2000	2000	2000	2000	2000	2000	5500	5500	5500	5500	5500
7	Max Current	6000	4500	4500	4500	4500	4500	4500	4500	5500	5500	8300	8300	8300	8300	8300
8	Stator Resist.	109	450	450	450	450	450	450	450	135	135	108	108	108	108	108
9	Synch. Induct.	24	133	133	133	133	133	133	133	100	100	63	63	63	63	63
10	P.M. Flux	1654	2515	2515	2515	2515	2515	2515	2515	2883	2883	2500	2500	2500	2500	2500
11	Current Kp	627	1080	1080	1080	1080	1080	1080	1080	605	605	650	650	650	650	650
12	Current Ki	703	1270	1270	1270	1270	1270	1270	1270	444	444	497	497	497	497	497
13	Speed Kp	4000	4000	4000	4000	4000	4000	4000	4000	4000	4000	4000	4000	4000	4000	4000
14	Speed Ki	30	30	30	30	30	30	30	30	100	100	25	25	25	25	25
15	Flux fb. Gain	10	10	10	10	10	10	10	10	10	10	10	10	10	10	10
16	Phase Offset	0	0	0	0	0	0	0	0	0	0	0	0	0	0	0
17	Startup Time	800	800	800	800	800	800	800	800	800	800	800	800	800	800	800
18	Flux est. filter tau	10	10	10	10	10	10	10	10	10	10	10	10	10	10	10
19	Sampling Freq.	13600	13600	13600	13600	13600	13600	13600	13600	13600	13600	13600	13600	13600	13600	13600
20	Freq. Ratio	1	1	1	1	1	1	1	1	1	1	1	1	1	1	1
21	Fixed speed setting	0	0	0	0	0	0	0	0	0	0	0	0	0	0	0
22	Max. block. current	1000	1000	1000	1000	1000	1000	1000	1000	1000	1000	1000	1000	1000	1000	1000
23	Min. block. current	150	150	150	150	150	150	150	150	250	250	250	250	250	250	250
24	Blocking time	200	200	200	200	200	200	200	200	200	200	200	200	200	200	200
25	Alignment current	3000	3000	3000	3000	3000	3000	3000	3000	2000	2000	5500	5500	5500	5500	5500
26	Alignment time	100	100	100	100	100	100	100	100	200	200	100	100	100	100	100
27	Id Fall time	50	50	50	50	50	50	50	50	50	50	50	50	50	50	50
28	Id ref	0	0	0	0	0	0	0	0	0	0	0	0	0	0	0
29	Max temp 1	750	750	750	750	750	750	750	750	750	750	750	750	750	750	750
30	Asynchronous Slip	0	0	0	0	0	0	0	0	0	0	0	0	0	0	0
31	PID Pos./Neg. Coeff.	0	0	0	0	0	0	0	0	0	0	0	0	0	0	0
32	Avoid range start	20000	20000	20000	20000	20000	20000	20000	20000	20000	20000	20000	20000	20000	20000	20000
33	Avoid range end	20000	20000	20000	20000	20000	20000	20000	20000	20000	20000	20000	20000	20000	20000	20000
34	Input type	1	1	1	1	1	1	1	1	1	1	1	1	1	1	1
35	Stop speed	20000	20000	20000	20000	20000	20000	20000	20000	20000	20000	20000	20000	20000	20000	20000
36	Maximum Power	1050	1050	1050	1050	1050	1050	1050	1050	1050	1050	2100	2100	2100	2100	2100
37	Power Kp	1000	1000	1000	1000	1000	1000	1000	1000	1000	1000	1000	1000	1000	1000	1000
38	Power Ki	14000	14000	14000	14000	14000	14000	14000	14000	14000	14000	14000	14000	14000	14000	14000
39	Constant Airflow	0	0	0	0	0	0	0	0	0	0	0	0	0	0	0
40	Kp Flow	200	200	200	200	200	200	200	200	200	200	200	200	200	200	200
41	Ki Flow	4000	4000	4000	4000	4000	4000	4000	4000	4000	4000	4000	4000	4000	4000	4000
42	Min Airflow	1000	500	1000	750	1000	1000	1000	1000	1000	1000	1000	1000	1000	1500	1500
43	Max Airflow	1950	3000	3500	2750	3000	3250	3250	3250	3750	4000	5000	4500	5000	4500	5000
44	Fan Model	1	2	3	4	5	6	7	8	9	10	1	2	3	4	5
45	Modbus Addr	1	1	1	1	1	1	1	1	1	1	1	1	1	1	1
46	Alarm/Tacho/Thresh	0	0	0	0	0	0	0	0	0	0	0	0	0	0	0
47	Modbus Speed	96	96	96	96	96	96	96	96	96	96	96	96	96	96	96
48	Modbus Stop Bits	0	0	0	0	0	0	0	0	0	0	0	0	0	0	0
49	Max In Current	0	0	0	0	0	0	0	0	0	0	0	0	0	0	0
50	External Set	0	0	0	0	0	0	0	0	0	0	0	0	0	0	0
51	Kp ext	0	0	0	0	0	0	0	0	0	0	0	0	0	0	0
52	Ki ext	0	0	0	0	0	0	0	0	0	0	0	0	0	0	0
53	Kd ext	0	0	0	0	0	0	0	0	0	0	0	0	0	0	0
54	Time	0	0	0	0	0	0	0	0	0	0	0	0	0	0	0
55	Speed Threshold	0	0	0	0	0	0	0	0	0	0	0	0	0	0	0
56	Comm. Timeout	0	0	0	0	0	0	0	0	0	0	0	0	0	0	0
57	Limit RPM min	400	400	400	400	400	400	400	400	400	400	300	300	300	300	300
58	Limit RPM MAX	3000	2000	2000	2000	2000	2000	2000	2000	2000	2000	2000	2000	2000	1600	1600
59	Limit I OUT	6000	4500	4500	4500	4500	4500	4500	4500	5500	5500	8300	8300	8300	8300	8300
60	Limit P MAX	1050	1050	1050	1050	1050	1050	1050	1050	1050	1050	2100	2100	2100	2100	2100
61	Limit I INPUT	0	0	0	0	0	0	0	0	0	0	0	0	0	0	0
62	Date	0	0	0	0	0	0	0	0	0	0	0	0	0	0	0
63	Serial	0	0	0	0	0	0	0	0	0	0	0	0	0	0	0

Fig.46 – Holding Registers



The Holding Register handling limits as 1,2,7,36,42 and 43 must be set with the fan stop. Changing the parameters during functioning may cause unexpected behavior.

7.3- Holding Registers Description

Holding Register 0: RESET [Adim] **(Default = 0)**

This register can be used to reset the fan by writing the value 1 on it and putting the analog input to 0V. The driver will reset any error condition and it will try to restart.



Don't write other values than 1.

Other values could reset all the registers to a neutral configuration and must be sent back to NG for a reconfiguring.

Range: 0 or 1

Holding Register 1: Min Speed [RPM] **(Default = min value for each fan type)**

This register is be used to set the minimum speed of the fan.

Range 1kW driver: $400rpm \leq MinSpeed \leq 1000rpm$

Range 2kW driver: $300rpm \leq MinSpeed \leq 1000rpm$

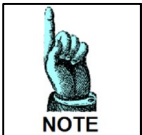

The min speed must be set below the max achievable speed depending on the application and the working point.

Holding Register 2: Max Speed [RPM] **(Default = max value for each fan type)**

This register can be used to set the max speed of the fan.

(For special application the max possible limits could be reviewed only by Nicotra | Gebhardt technicians)



Don't set the Min Speed higher than the Max Speed otherwise the driver stops working without any alarm indication!

Range: $MinSpeed < MaxSpeed \leq [3000 \text{ or } 2000 \text{ or } 1600]rpm$ depending on the fan type

Holding Register 7: Max Current [mA] **(Default max value for each fan type)**

This register can be used to reduce the max motor current.

(For special application the max possible limits could be reviewed only by Nicotra | Gebhardt technicians)

Range 1kW driver: $2000mA \leq MaxCurrent \leq \begin{cases} 4500mA \\ 5500mA \end{cases}$

Range 2kW driver: $5500mA \leq MaxCurrent \leq 8300mA$

Holding Register 21: Fixed Speed setting. [RPM] **(Default = 0)**

This register can be used to set a fixed speed.

The register is active when the Input Type Holding Register 34 is set to the value 2.

Type of setting= PERMANENT

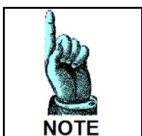

When another operating mode is selected, this register should be put at 0 value.

Range: $MinSpeed < MaxSpeed \leq [3000 \text{ or } 2000 \text{ or } 1600]rpm$ depending on the fan type

Holding Register 30: Asynchronous Slip. [%] **(Default = 0)**

This register can be used to set the slip of an emulated ACIM motor.
 The register is active when the Input Type Holding Register is set to the value 9.
 Type of setting= PERMANENT

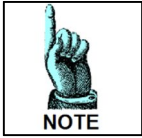

When another operating mode is selected, this register should be put at 0 value.

Range: $0\% \leq \text{AsynchronousSlip} \leq 100\%$

Holding Register 34: Input Type [Adim] **(Default = 1 → Analog Speed Control)**

This register defines all the possible operating modes:

- | | |
|---|---|
| 0- <u>Modbus Speed Control:</u> | The speed is set by modifying the register 66 (volatile) |
| 1- <u>Analog Speed Control:</u> | The speed is set through the analog signal |
| 2- <u>Modbus Fixed Speed Control:</u> | The speed is set by modifying the register (permanent) |
| 3- <u>Master & Slave:</u> | The fan is configured as slave and follows the speed of the master. |
| 4- <u>Analog Constant Airflow:</u> | The constant airflow is set through the analog signal |
| 5- <u>Modbus Constant Airflow:</u> | The constant airflow is set by modifying the register 66 (volatile) |
| 6- <u>Modbus Fixed Constant Airflow:</u> | The constant airflow is set by modifying the reg. 39 (permanent) |
| 7- <u>Analog Asynchronous Emulation:</u> | The emulation is set through the analog signal |
| 8- <u>Modbus Asynchronous Emulation:</u> | The emulation is set by modifying the register 66 (volatile) |
| 9- <u>Modbus Fixed Asynchronous Emulation:</u> | The emulation is set by modifying the register 30 (permanent) |
| 10- <u>Analog Ref. PID Closed Control Loop:</u> | NOT AVAILABLE ON DDMP (Second Analog input not present) |
| 11- <u>Modbus Ref. PID Closed Control Loop:</u> | The PID ref. is set by modifying the register 66 (volatile) |
| 12- <u>Modbus Fixed Ref. PID Closed Control Loop:</u> | The PID ref. is set by modifying the register 50 (permanent) |

Range: $0 \leq \text{InputType} \leq 12$



When the Input Type value is moved on Modbus mode, the fan stops.
When the Input Type value is moved on a Fixed mode or an Analog mode, the fan changes its behavior basing on the target put into the registers 21, 30, 39, 50 or the analog signal present.

Holding Register 36: Maximum Power [W] **(Default = max value for each driver type)**

This register can be set for reducing the power out to the motor.
 (For special application the max possible limits could be reviewed only by Nicotra | Gebhardt technicians)

Range 1kW driver: $100W \leq \text{MaximumPower} \leq 1050W$

Range 2kW driver: $100W \leq \text{MaximumPower} \leq 2100W$

Holding Register 39: Constant Airflow [m3/h] **(Default = 0)**

This register can be used to set the constant airflow value.
 The register is active when the Input Type Holding Register is set to the value 6.
 Type of setting= PERMANENT

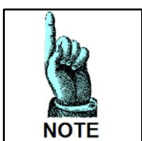

When another operating mode is selected, this register should be put at 0 value.

Range: $\text{MinAirflow} \leq \text{ConstAirflow} \leq \text{MaxAirflow}$

Holding Register 42: Min Airflow [m3/h] **(Default = min reliable value)**

This register can be used to set the min constant airflow.

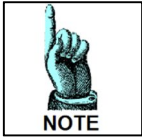

It is suggested to maintain the Min Airflow above the default value. Below the default limit the correct functioning or the precision of the constant airflows are not guaranteed.

Range: $Default \leq MinAirflow \leq MaxAirflow$

Holding Register 43: Max Airflow [m3/h] **(Default = max reliable value)**

This register can be used to set the min constant airflow.

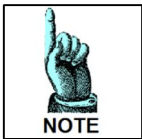

It is suggested to maintain the Max Airflow below the default value. Above the default limit the correct functioning or the precision of the constant airflows are not guaranteed.

Range: $MinAirflow \leq MaxAirflow \leq Default$

Holding Register 44: **Fan Model [Adim]**

This register can be only read and it gives an important information about the configuration of the fan loaded into the driver.

This register combined with the **Input Register 0** and the **Input Register 1** can be used to check if the fan configuration is correct.

Range for 1kW Driver: $1 \leq FanType \leq 10$

Range for 2kW Driver: $1 \leq FanType \leq 5$

Holding Register 45: Modbus Address [Adim] **(Default = 1)**

This register can be used to change the Modbus address of a driver.

Range: $1 \leq ModbusAddress \leq 247$

Holding Register 46: Tachometric/ Alarm/Threshold [Adim] **(Default = 0)**

This register can be used to set the digital output function.

The possible settings are:

- 0- **Tachometric:** The digital output indicates the measured speed through a PWM signal.
- 1- **Alarm:** The digital output indicates when an alarm occur.
- 2- **Threshold:** The digital output indicates when the speed set in the **Holding Register 55** is overtaken

Range: 0 or 1 or 2

Holding Register 47: Modbus Speed [10^{-1} kbps] **(Default = 96)**

This register can be used to set the Modbus speed.

Range:

- 96 → corresponding to 9.6kbps
- 192 → corresponding to 19.2kbps
- 384 → corresponding to 38.4kbps (not available using the opto-insulated terminal block)
- 576 → corresponding to 57.6kbps (not available using the opto-insulated terminal block)

Values outside the nominal ones will be coerced to a correct value.

Holding Register 48: Modbus Stop Bits [Adim] **(Default = 0)**

This register can be used to set the parity and the stop bits.

Range:

- 0: 2 Stop Bits/No Parity
- 1: 1 Stop Bit/Even Parity
- 2: 1 Stop Bit/Odd Parity

Holding Register 50: External Set [$10^{-1}V$] **(Default = 0)**

This register can be used to set the reference of the PID control.

The register is active when the Input Type Holding Register is set to the value 12.

Type of setting= PERMANENT

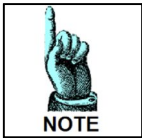

When another operating mode is selected, this register should be put at 0 value.

Range: $0V \leq ExternalSet \leq 100 \times 10^{-1}V$

Holding Register 51: K_p [Adim] **(Default = 0)**

This register can be used to set the Proportional Gain of the PID control.

Range: $0 \leq K_p \leq 32767$

Holding Register 52: K_i [Adim] **(Default = 0)**

This register can be used to set the Integral Gain of the PID control.

Range: $0 \leq K_i \leq 32767$

Holding Register 53: K_d [Adim] **(Default = 0)**

This register can be used to set the Derivative Gain of the PID control.

Range: $0 \leq K_d \leq 32767$

Holding Register 54: Period [ms] **(Default = 0)**

This register can be used to set the time constant of the PID control.

Range: $0 \leq T_{PID} \leq 32767$

Holding Register 55: Speed Threshold [RPM] **(Default = 0)**

This register can be used to set the speed threshold. When the measured speed in the [Input Register 3](#) overtakes the threshold value.

Speed Threshold =0 means that it is **DEACTIVATED**

Range: $0 \leq SpeedThreshold \leq MaxSpeed$

Holding Register 56: Communication Timeout [s] **(Default = 0)**

This register can be used to set a timeout period for the communication. At the end of the period set into the register the fan stops and an Alarm2 indication 0xFF.

To restart a reset command must be sent.

Communication Timeout =0 means that it is **DEACTIVATED**

Range: $0 \leq CommunicationTimeout \leq 9h8m8s$

7.4- Input Register Description

The Modbus Input Registers shown in fig. 47 are in total 33 but only the underlined ones are useful for the user.

REG	Description	
<u>0</u>	<u>Firmware Version</u>	[Adim]
<u>1</u>	<u>Driver Model</u>	[Adim]
<u>2</u>	<u>Speed Reference</u>	[rpm]
<u>3</u>	<u>Measured Speed</u>	[rpm]
4	Imposed Frequency	[Hz]
5	Direct Current	[mA]
6	Quadrature Current	[mA]
7	Direct Voltage	[10 ⁻¹ V]
8	Quadrature Voltage	[10 ⁻¹ V]
<u>9</u>	<u>Bus Voltage</u>	[10 ⁻¹ V]
<u>10</u>	<u>Alarm (1)</u>	[Adim]
11	Flags	[Adim]
<u>12</u>	<u>Motor Current</u>	[mA]
<u>13</u>	<u>Motor Voltage</u>	[10 ⁻¹ V]
<u>14</u>	<u>Analog Input</u>	[10 ⁻¹ V]
<u>15</u>	<u>Module Temperature</u>	[10 ⁻¹ °C]
16	Not Used	---
<u>17</u>	<u>Alarm (2)</u>	[Adim]
18	Mode	[Adim]
19	Stator Resistance	[10 ⁻¹ Ohm]
20	Synchronous inductance	[10 ⁻¹ mH]
21	P.M. flux	[10 ⁻¹ mWb]
22	Current Loop kp	[Adim]
23	Current Loop ki	[Adim]
24	PWM frequency	[Hz]
25	Sampling frequency	[Hz]
26	Extra Flags	[Adim]
27	Digital Input	[Adim]
28	Analog Input 0	x 10V/2 ¹⁶
29	Analog Input 1	x 10V/2 ¹⁶
30	Analog Input 2	x 10V/2 ¹⁶
<u>31</u>	<u>Measured Power</u>	[W]
32	Input Current AVG	[mA]

Fig.47 – Input Registers

Input Register 0: Firmware Version [Adim]

This register indicates the firmware uploaded into the DDMP driver.

This register combined with the Input Register 1 and the Holding Register 44 can be used to check if the fan configuration is correct.



All the features indicates in this manual are referred to a firmware Revision 5 or higher

Input Register 1: Driver Type [Adim]

This register indicates the driver type that for the DDMP are:

1kW Driver = 41504

2kW Driver = 45600

This register combined with the Input Register 0 and Holding Register 44 can be used to check if the fan configuration is correct.

Input Register 2: Speed Reference [rpm]

This register indicates the speed reference during the functioning. During the starting phase is equal the Min Speed and then gradually increases to the target speed depending on the selected mode.

Range: $MinSpeed \leq Speed_{REFERENCE} \leq MaxSpeed$

Input Register 3: Measured Speed [rpm]

This register indicates the speed during the functioning.

Range: $0 \leq \text{MeasuredSpeed} \leq \text{MaxSpeed}$

Input Register 9: Bus Voltage [$10^{-1}V$]

This register indicates the rectified voltage after the PFC stage.

Driver OFF-Fan OFF: $0V$

Driver ON-Fan OFF: $V_{AC} \cdot \sqrt{2} = \begin{cases} 283V \longrightarrow \text{min} \\ 325V - \text{Default} \\ 373V \longrightarrow \text{MAX} \end{cases}$

Driver ON-Fan ON: $\text{Driver1kW} = 385V$

$\text{Driver2kW} = 400V$

Input Register 10: Alarm1 [Adim]

This register must be combined with the Alarm2 register (see the alarm lookup table)

Range: $0 \leq \text{Alarm1} \leq 4$

Input Register 12: Motor Current [mA]

This register indicates the peak value of the line current module [A]. To know the rms value, has to be divided by $\sqrt{2}$.

Range: $0 \leq \text{MotorCurrent} \leq \text{MaxCurrent}$ depending on the fan sizes

Input Register 13: Motor Voltage [$10^{-1}V$]

This register indicates the peak value of the phase voltage module [V]. To know the rms line to line value, has to be multiplied by $\sqrt{3}/2$.

Range: $0V \leq \text{MotorVoltage} \leq 2250 \cdot 10^{-1}V$

Input Register 14: Analog Input [$10^{-1}V$]

This register indicates the analog voltage value present at the input.

Range: $0V \leq \text{ANALOG}_{\text{Input}} \leq 100 \cdot 10^{-1}V$

Input Register 15: Module Temperature [$10^{-1}^{\circ}C$]

This register indicates the temperature of the power module of the driver. When the value exceeds $75^{\circ}C$ the driver enters in a derating process where the performance are automatically decreased until a thermal equilibrium below $75^{\circ}C$ is reached.

If this equilibrium is not reached the fan stops and an alarm condition is activated. As soon as the heating decreases and the power module temperature is below $75^{\circ}C$, the alarm is automatically reset.

Input Register 17: Alarm2 [Adim]

This register must be combined with the Alarm1 register (see the alarm lookup table)

Range: $0 \leq \text{Alarm2} \leq 255$

Input Register 31: Measured Power [W]

This register indicates the absorbed power.

Range: $0 \leq \text{MeasuredPower} \leq \text{MaximumPower}$ depending on the fan sizes

7.5- Modbus USB-RS485 converter

As accessory it's possible to use a Nicotra | Gebhardt USB-RS485 converter code K431A7 (see fig. 48)
 The drivers for **CP210x_VCP_Windows** can be downloaded at
<https://www.silabs.com/products/mcu/Pages/USBtoUARTBridgeVCPDrivers.aspx>



Fig.48 – USB-RS485

7.6- OFFLINE Cable

It is possible to configure the DDMP Driver in an offline mode by using a dedicated cable (Nicotra | Gebhardt code K431A6).

(Cable specifications: **USB to TTL Serial Cable 5V**. Drivers available at [Http://ftdichip.com](http://ftdichip.com))

In fig. 49 is shown the particular of the OFFLINE connector with the description of the pins.



Fig.49 – White OFFLINE connector and OFF line Cable



During the OFFLINE operation the driver MUST BE DISCONNECTED FROM POWER SUPPLY or could be damaged or destroyed.

7.7- Bluetooth Connection

It is possible to use the OFFLINE connector even if the driver is powered on, but the device connected to it must be floating and not accessible by the end user.

In fact the power supply of the OFFLINE connector is 5V but directly obtained from the bus line without opto-insulators. A very small Bluetooth module that is suitable for this application is the HC-06 module for Arduino applications fig. 50 (Refer to the HC-06 manufacturer for datasheet and configuration).

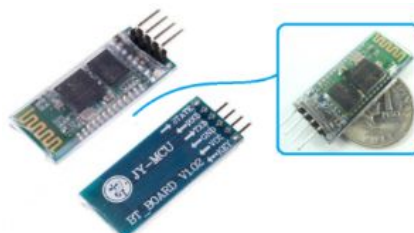

Fig.50 – HC-06 module

In figure 51 are shown the connection.

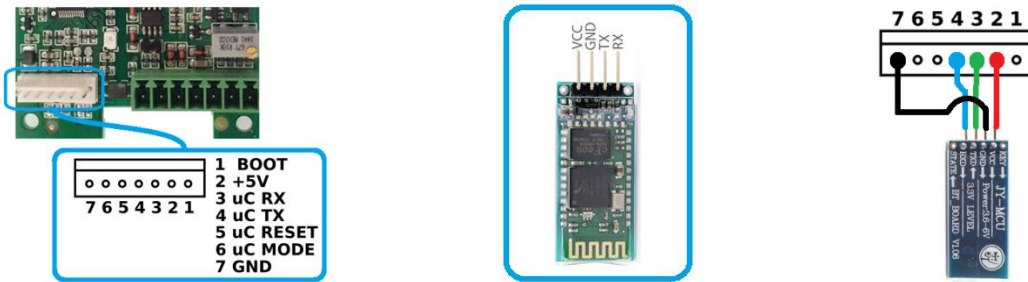

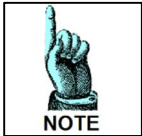

Fig.51 – Connections

Note: an available  Google Play freeware App is CDE: Bluetooth Serial Communication 



With Bluetooth devices the EMC is not guaranteed.

8- ALARM HANDLING

When a malfunctioning occurs the driver has two possible behaviors depending on the cause of the alarm:

- 1) **BLOCKING** The cause of the alarm is very dangerous → The driver stops immediately. To restart the fan, once the problem is corrected, it is necessary to reset the fan or power the driver off for 5 minutes.
- 2) **AUTO-RESTARTING** The cause of the alarm is contingent to a wrong setting or wrong working condition. The alarm indications are activated, but after some seconds the fan tries to restart automatically

8.0.1- Monitoring:

The alarms can be monitored through three different ways:

- a) Modbus Registers
- b) LED blinking
- c) Digital Output

8.0.2- Modbus Registers - Alarm description:

In fig.52 are indicated the possible alarms and the values stored in the related Modbus Input Register 10 and Input Register 17.

Alarm1	Alarm2	Description	Actions
0	0	Normal operation, no errors	NO ACTIONS
1	0	Memory error	BLOCKING
2	0	Short-circuit	BLOCKING
3	0	Loss of synchronism with the motor	AUTO-RESTARTING
4	1	Input voltage outside range (only with motor stopped)	AUTO-RESTARTING
4	32	Bus voltage over 430V during operation (instantaneous measurement)	AUTO-RESTARTING
4	33	Bus voltage below 350V during operation (instantaneous measurement)	AUTO-RESTARTING
4	34	Input relay not closed	AUTO-RESTARTING
4	49	Motor cable U disconnected	BLOCKING
4	50	Motor cable V disconnected	BLOCKING
4	51	Motor cable W disconnected	BLOCKING
4	113	Overtemperature	AUTO-RESTARTING
4	255	Loss of Communication	BLOCKING

Fig. 52 – Alarm description



An occurring alarm with NO ACTIONS could imply a dangerous functioning anyway. The Driver is NOT protected against a very high power supply voltage. A very low power supply voltage during the motor running could damage Driver

8.0.3- Blinking Led - Alarm description:

In figure 53 is shown the blinking LED (i.e. board of the 1kW driver).

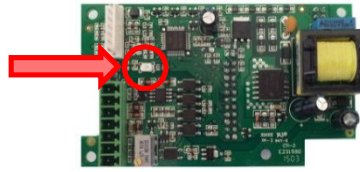

Fig. 53 – Blinking LED

In the fig 54 there is the legend for reading the alarm through the LED present on the Control Board.

Description	Blinking
Normal operation, no errors	1 Blink/s
Memory error	2 Blink/s
Short-circuit	3 Blink/s
Loss of synchronism with the motor	4 Blink/s
Input voltage outside range (only with motor stopped)	4 Blink/s
Bus voltage over 430V during operation (instantaneous measurement)	4 Blink/s
Bus voltage below 350V during operation (instantaneous measurement)	4 Blink/s
Input relay not closed	4 Blink/s
Motor cable U disconnected	4 Blink/s
Motor cable V disconnected	4 Blink/s
Motor cable W disconnected	4 Blink/s
Overtemperature	4 Blink/s
Loss of Communication	4 Blink/s

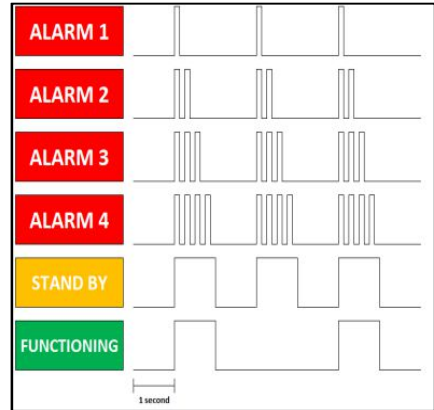

Fig. 54 – Alarm description – Blinking LED

8.0.4- Digital Output

The driver output can be configured as Alarm output by modifying the Holding Register 46 to value 1.

During the normal functioning the output value is 0V and when an alarm occurs the output value is 5V see fig. 55

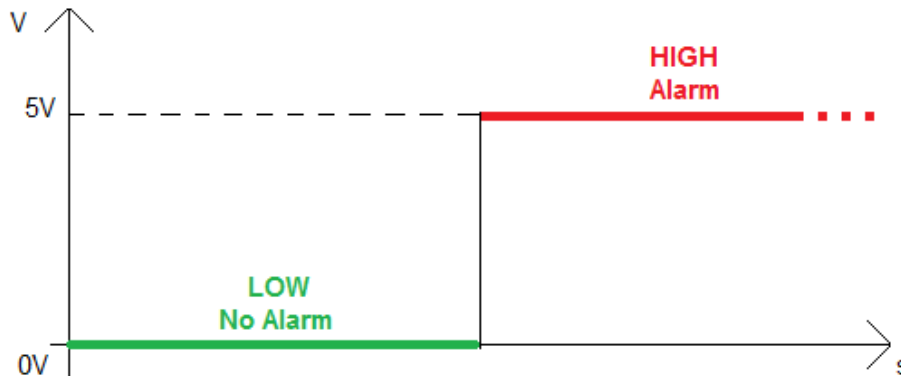

Fig. 55 – Digital Output functioning



The output is NOT provided by a relay
The output is NOT a dry contact
DON'T connect power cable to the output

9- AVAILABLE SOFTWARE

A freeware software is available on Nicotra||Gebhardt site (<http://www.nicotra-gebhardt.com>) for monitoring the performance of the DDMP fans in the final customer units. Please refer to the “*Fan Configuration Program*” manual for more details.

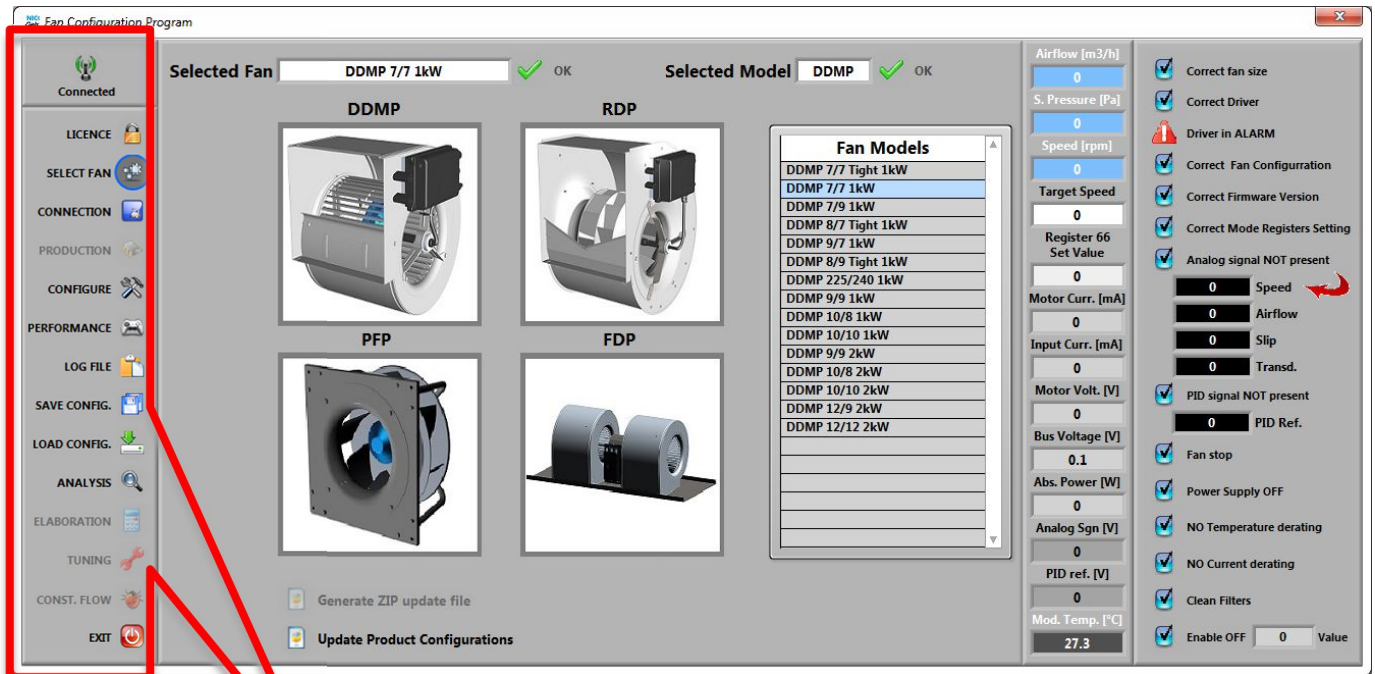

Fig. 56 – Available masks

In the figure 56 are shown all the accessible end user masks basing on the password inserted.

The disabled and greyed out registers are respectively for Nicotra||Gebhardt production line and for the laboratory only.



***The software can be used for configuring the fan and monitoring the performance.
The performance is estimated through an algorithm and therefore subjected to variable tolerance depending on the working point, airflow stability and the constant algorithm resolution itself.***

Here in the figures from 57 to 65 are shown the details of the masks.



Fig. 57

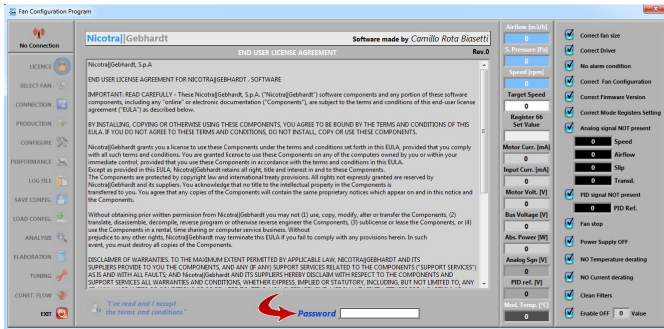

Fig. 58

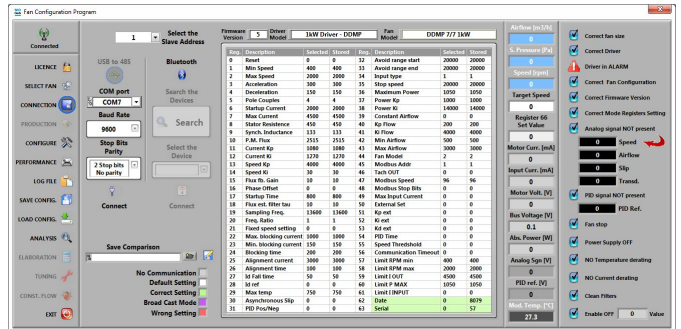

Fig. 59

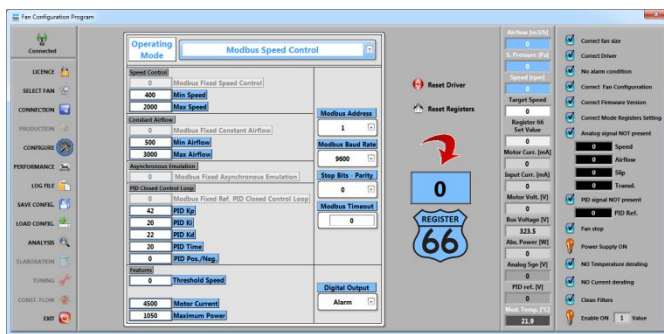

Fig. 60

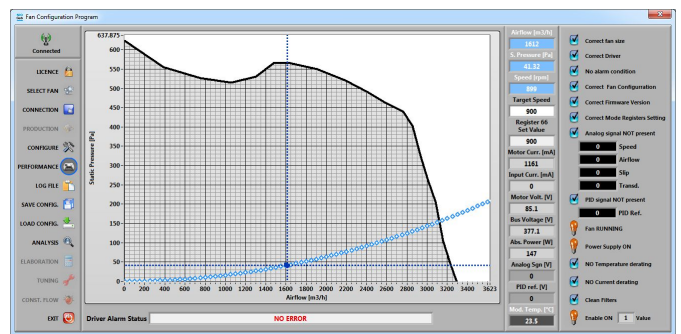

Fig. 61

Reg	Description	Values	Reg	Description	Values	Reg	Description	Values
0	Reset	0	16	Phase Offset	0	32	Avoid range start	20000
1	Min Speed	400	17	Start-up Time	800	33	Avoid range end	20000
2	Max Speed	2000	18	Flux end Filter lag	10	34	Input Type	1
3	Acceleration	300	19	Sampling Freq.	13000	35	Stop speed	20000
4	Deceleration	150	20	Free Run	1	36	Maximum Power	3500
5	Pulse Coupler	4	21	Flux speed setting	37	37	Power Kp	1000
6	Start-up Current	2000	22	Min. blocking current	150	39	Constant Airflow	0
7	Max Current	4500	23	Max. blocking current	3000	41	Ki Flow	200
8	Stator Resistance	450	24	Blowing time	200	40	Limit RPM max	2000
9	Synch. Inductance	133	25	Alignment time	100	42	Limit RPM min	400
10	P.M. Flux	2515	26	Flux Offset	50	43	Max Airflow	3000
11	Current Kp	4000	27	Id ref	44	44	Limit I/OFF	4500
12	Current Ki	1270	28	Id ref	44	45	Limit I MAX	1950
13	Speed Kp	4000	29	Max temp	750	45	Modbus Addr	61
14	Speed Ki	30	30	Apogee/Inrush Slip	0	46	Tech I/OFF	0
15	Flux Th. Gain	10	31	PID Pos/Neg	0	47	Modbus Speed	96

Fig. 62

Reg	Description	Values	Reg	Description	Values	Reg	Description	Values
0	Reset	0	16	Phase Offset	0	32	Avoid range start	20000
1	Min Speed	400	17	Start-up Time	800	33	Avoid range end	20000
2	Max Speed	2000	18	Flux end Filter lag	10	34	Input Type	1
3	Acceleration	300	19	Sampling Freq.	13000	35	Stop speed	20000
4	Deceleration	150	20	Free Run	1	36	Maximum Power	3500
5	Pulse Coupler	4	21	Flux speed setting	37	37	Power Kp	1000
6	Start-up Current	2000	22	Min. blocking current	150	39	Constant Airflow	0
7	Max Current	4500	23	Max. blocking current	3000	41	Ki Flow	200
8	Stator Resistance	450	24	Blowing time	200	40	Limit RPM max	2000
9	Synch. Inductance	133	25	Alignment time	100	42	Limit RPM min	400
10	P.M. Flux	2515	26	Flux Offset	50	43	Max Airflow	3000
11	Current Kp	4000	27	Id ref	44	44	Limit I/OFF	4500
12	Current Ki	1270	28	Id ref	44	45	Limit I MAX	1950
13	Speed Kp	4000	29	Max temp	750	45	Modbus Addr	61
14	Speed Ki	30	30	Apogee/Inrush Slip	0	46	Tech I/OFF	0
15	Flux Th. Gain	10	31	PID Pos/Neg	0	47	Modbus Speed	96

Fig. 63

Reg	Description	Values	Reg	Description	Values	Reg	Description	Values
0	Reset	0	16	Phase Offset	0	32	Avoid range start	20000
1	Min Speed	400	17	Start-up Time	800	33	Avoid range end	20000
2	Max Speed	2000	18	Flux end Filter lag	10	34	Input Type	1
3	Acceleration	300	19	Sampling Freq.	13000	35	Stop speed	20000
4	Deceleration	150	20	Free Run	1	36	Maximum Power	3500
5	Pulse Coupler	4	21	Flux speed setting	37	37	Power Kp	1000
6	Start-up Current	2000	22	Min. blocking current	150	39	Constant Airflow	0
7	Max Current	4500	23	Max. blocking current	3000	41	Ki Flow	200
8	Stator Resistance	450	24	Blowing time	200	40	Limit RPM max	2000
9	Synch. Inductance	133	25	Alignment time	100	42	Limit RPM min	400
10	P.M. Flux	2515	26	Flux Offset	50	43	Max Airflow	3000
11	Current Kp	4000	27	Id ref	44	44	Limit I/OFF	4500
12	Current Ki	1270	28	Id ref	44	45	Limit I MAX	1950
13	Speed Kp	4000	29	Max temp	750	45	Modbus Addr	61
14	Speed Ki	30	30	Apogee/Inrush Slip	0	46	Tech I/OFF	0
15	Flux Th. Gain	10	31	PID Pos/Neg	0	47	Modbus Speed	96

Fig. 64

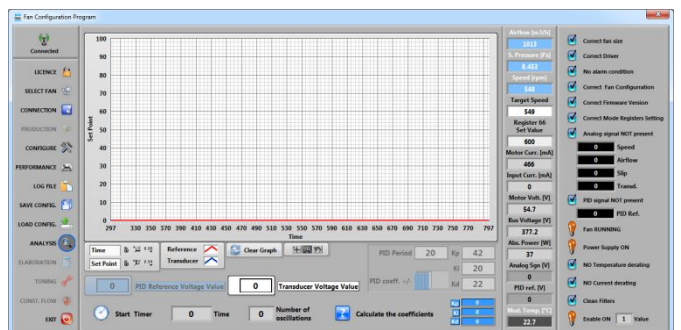

Fig. 65

NOTES

NOTES

Nicotra Gebhardt worldwide

SPAIN

Ctra. Alcalá-Villar del Olmo, Km. 2,830
28810 Villalbilla-Madrid
Phone +34 918-846110
Fax +34 918-859450
E-mail info@nicotra.es

c/.Coso, 67-75, esc. 1.a,1.oB
50001 Zaragoza
Phone +34 976-290550
Fax +34 976-298127
E-mail gebhardt@teletel.es

BELGIUM

Haeghensgoed, 13 - 00/01
9270 Laarne
Phone +32 (0)9-336-00-01
Fax +32 (0)9-336-00-05
E-mail info.nicotra@nicotra.be

FRANCE

Leader's Park Bat A1
3 chemin des Cytises
69340 Francheville
Phone +33 (0)4 72 79 01 20
Fax +33 (0)4 72 79 01 21
E-mail g.cauche@nicotra-gebhardt.com

SWEDEN

Box 237
Kraketorpsgatan 30
43123 Mölndal
Phone 0046 31-874540
Fax 0046 31-878590
E-mail info.se@nicotra-gebhardt.com

GREAT BRITAIN

Unit D, Rail Mill Way
Parkgate Business Park
Rotherham
South Yorkshire
S62 6JQ
Phone +044 01709-780760
Fax +044 01709-780762
E-mail sales@nicotra.co.uk

UNITED STATES

PO BOX 900921
Sandy, Utah 84090
Phone 001(801) 733-0248
Fax 001(801) 315-9400
Mobile 001(801) 682 0898
E-mail mike.sehgal@gebhardtffans.com
<http://www.gebhardtffans.com/>



MALAYSIA

Lot 1799, Jalan Balakong
Taman Perindustrian Bukit Belimbing
43300 Seri Kembangan
Selangor
Phone +603 8961-2588
Fax +603 8961-8337
E-mail info_malaysia@nicotra-gebhardt.com

THAILAND

6/29 Soi Suksawadi 2, Moo 4, Suksawadi Road,
Kwang Jomthong, Khet Jomthong,
Bangkok 10150
Phone +662 476-1823-6
Fax +662 476-1827
E-mail sales@nicotra.co.th

SINGAPORE

No. 15 West Coast Highway
04-08 Pasir Panjang Building
Singapore 117861
Phone (065) 6265-1522
Fax (065) 6265-2400
E-mail info@gebhardt-singapore.com

AUSTRALIA

65 Yale Drive,
Epping, VIC 3076
Phone +61 3 9017 5333
Fax +61 3 8401 3969
E-mail info@nicotra.com.au

INDIA

Plot no 28F & 29, Sector-31,Kasna,
Greater Noida-201 308 U.P (India)
Phone +91 120 4783400
Phone +91 22 65702056 (Mumbai)
Phone +91 80 25727830 (Bangalore)
E-mail info@nicotraindia.com

CHINA

88 Tai'An Road, XinQiao, ShiJI, Panyu
Guangzhou 511450
PR CHINA
Phone +86 (0)20-39960570
Fax +86 (0)20-39960569
E-mail sales@nicotra-china.com

Nicotra Gebhardt Germany

Nicotra Gebhardt GmbH
Gebhardtstraße 19-25
74638 Waldenburg
Phone +49 (0)7942 101 0
Fax +49 (0)7942 101 170
E-mail info@nicotra-gebhardt.com

Nicotra Gebhardt Italy

Nicotra Gebhardt S.p.A
Via Modena, 18
24040 Zingonia (BG)
Phone +39 035 873 111
Fax +39 035 884 319
E-mail info@nicotra-gebhardt.com

nicotra-gebhardt.com