

EC FANS

Operating Manual

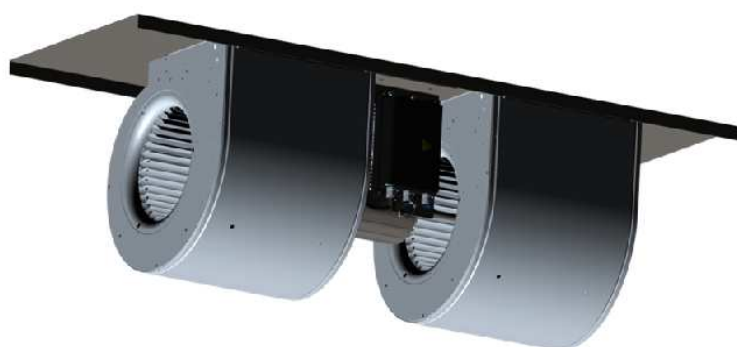
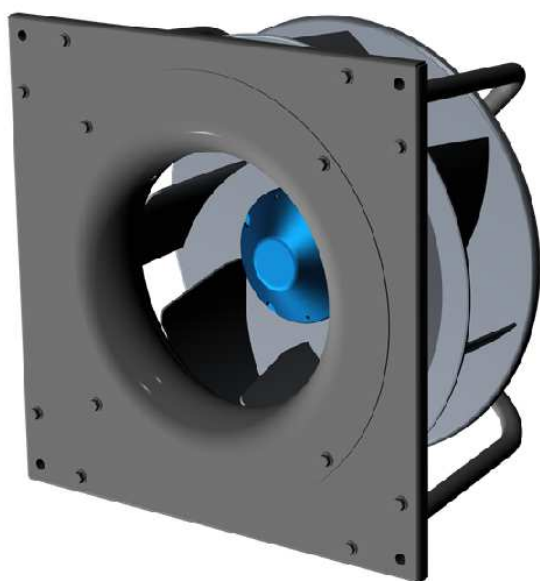
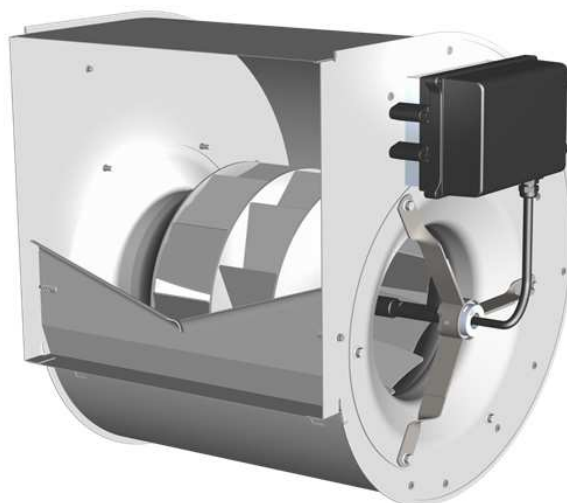
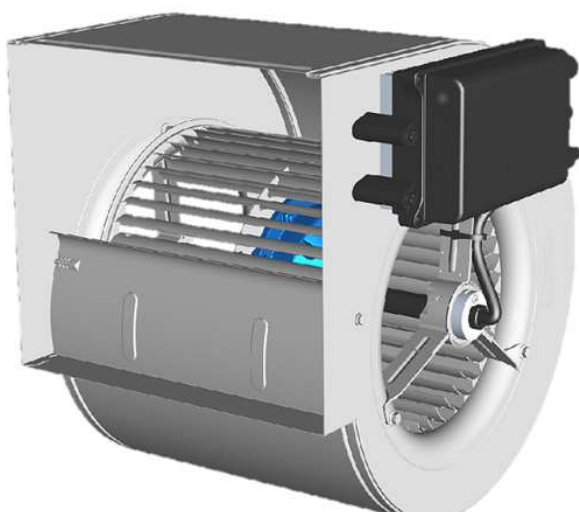

TABLE OF CONTENTS

DEFINITIONS AND WARNINGS	5
<i>Qualified personnel</i>	5
<i>Use for intended purpose only</i>	5
READ CAREFULLY	5
SAFETY INSTRUCTIONS	6
GENERAL	6
TRANSPORT & STORAGE	7
COMMISSIONING	7
OPERATION	7
REPAIR	7
AMBIENT OPERATING CONDITIONS	7
CE CONFORMITY	8
MECHANICAL AND ELECTRICAL SAFETY	8
ELECTRO-MAGNETIC COMPATIBILITY (EMC)	8
<i>Single-phase drive systems: PFP 1.35 kW, DDMP 1 kW, DDMP 2 kW, RDP 1 kW, RDP 2 kW, FDP 1 kW</i>	8
<i>Three-phase drive systems: PFP 2.6 kW, DDMP 2.6 kW, RDP 2.6 kW</i>	8
SAFE OPERATING AREA	9
PRODUCT OVERVIEW	10
<i>General Information</i>	10
CONNECTIONS	11
POWER SUPPLY	11
CONTROL BOARD CONNECTION	12
CONNECTION DETAILS	13
<i>Analog</i>	13
<i>Modbus Communication</i>	14
<i>Enable Signal</i>	14
<i>Transducer Input</i>	15
<i>+24V AUX Power supply</i>	15
<i>+12V AUX Power supply</i>	16
<i>Relay</i>	16
<i>Tachometric, Alarm and Filter Output</i>	16
<i>Input Impedances</i>	16
OPERATING MODES AND SETTING OPTIONS	17
SPEED CONTROL	17
<i>Analog Speed Control</i>	17
<i>Modbus Temporary Speed Control</i>	18
<i>Modbus Fixed Speed Control</i>	18
<i>Speed Control curves example</i>	18
CONSTANT AIRFLOW	19
<i>Analog Constant Airflow</i>	19
<i>Modbus Temporary Constant Airflow</i>	19
<i>Modbus Fixed Constant Airflow</i>	19

<i>Constant Airflow curves example</i> -----	20
ASYNCHRONOUS EMULATION -----	20
<i>Analog Asynchronous Emulation</i> -----	20
<i>Modbus Temporary Asynchronous Emulation</i> -----	21
<i>Modbus Fixed Asynchronous Emulation</i> -----	21
<i>Asynchronous Emulation curves example</i> -----	21
PID CLOSED CONTROL LOOP -----	22
<i>Analog ref. PID Closed Control Loop</i> -----	22
<i>Modbus Temporary ref. PID Closed Control Loop</i> -----	22
<i>Modbus Fixed ref. PID Closed Control Loop</i> -----	23
<i>Modbus Positive/Negative feedback</i> -----	23
CHANGING THE OPERATION MODE -----	23
OTHER FEATURES -----	24
FILTERS ALARM -----	24
FLYING START -----	25
REGENERATION -----	25
SKIP SPEED RANGE -----	25
SOFT START -----	25
SOA LIMITATIONS -----	26
<i>Speed Limitation</i> -----	26
<i>Power Limitation</i> -----	26
<i>Output Current Limitation</i> -----	27
<i>Input Current Limitation</i> -----	27
OTHER VARIABLES -----	27
<i>Bus Voltage</i> -----	27
<i>Motor Voltage</i> -----	27
ENABLE FUNCTION -----	28
DERATING AND OVERHEATING PROTECTIONS -----	28
<i>Driver overheating: DERATING</i> -----	28
<i>Motor overheating: THERMAL PROTECTOR</i> -----	28
MASTER&SLAVE MODE -----	29
<i>Master and Slave 0-5V PWM out</i> -----	29
<i>Master and Slave 0-10V PWM out</i> -----	30
COMMUNICATION -----	30
<i>Protocol interface:</i> -----	30
<i>Baud rate</i> -----	30
<i>Parity and Stop bits</i> -----	30
<i>Supported Function:</i> -----	30
<i>Modbus Communication Timeout</i> -----	30
<i>Modbus Address</i> -----	30
<i>Broadcast Address</i> -----	31
<i>RS-485 Default Communication Parameters</i> -----	31
<i>RS-232 (OFFLINE) Default Communication Parameters</i> -----	31
TEMPORARY HOLDING REGISTER -----	31
FIXED HOLDING REGISTER -----	31
HOLDING REGISTERS DESCRIPTION -----	32
INPUT REGISTER DESCRIPTION -----	36

FAN INFO AND MODBUS REGISTERS-----	37
ALARM HANDLING -----	38
<i>Monitoring</i> :-----	38
<i>Modbus Registers - Alarm description</i> :-----	38
<i>Blinking Led - Alarm description</i> :-----	38
<i>Digital Output</i> -----	39
<i>Alarm Reset</i> -----	39
AVAILABLE SOFTWARE-----	39
ANNEX -----	40
ANALOG SIGNAL CONSIDERATIONS-----	40
<i>Voltage and Speed</i> -----	40
<i>Potentiometer setting</i> -----	40
SENSORLESS CONSTANT PRESSURE-----	41
<i>Considerations</i> :-----	42
<i>Conclusion</i> :-----	43
SENSORLESS CONSTANT AIRFLOW-----	43
MASTER&SLAVE CONSIDERATIONS-----	44
<i>Characteristic of two forward curved fans in parallel at same speed</i> -----	44
PID TUNING PROCEDURE-----	46

DEFINITIONS AND WARNINGS



For the purpose of this documentation and the product warning labels, "Warning" indicates that death, severe personal injury or substantial damage to property can result if proper precautions are not taken.



For the purpose of this documentation and the product warning labels, "Caution" indicates that minor personal injury or material damage can result if proper precautions are not taken.

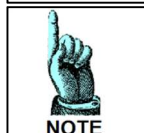

For the purpose of this documentation, "Note" indicates important information relating to the product or highlights part of the documentation for special attention.

Qualified personnel

For the purpose of this Instruction Manual and product labels, a "Qualified person" is someone who is familiar with the installation, mounting, start-up and operation of the equipment and the hazards involved. He or she must have the following qualifications:

- Trained and authorized to energize, de-energize, clear, ground and tag circuits and equipment in accordance with established safety procedures.
- Trained in the proper care and use of protective equipment in accordance with established safety procedures.
- Trained in rendering first aid.

Use for intended purpose only

The equipment may be used only for the application stated in the manual and only in conjunction with devices and components recommended and authorized by Nicotra Gebhardt.

Read carefully



Before installing and commissioning the fan, you must read carefully all safety instructions and warnings including all the warning labels attached to the equipment. Make sure that the warning labels are kept in a legible condition and replace missing or damaged labels.

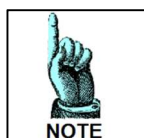

Nicotra||Gebhardt reserves the right to change without notice.

Information is also available from:

Nicotra Gebhardt S.p.A.
Via Modena, 18
24040 Ciserano Loc. Zingonia (BG)
Italy

Telephon: +39 035 873 111
Telefax: +39 035 884 319

E-mail: presales.italy@nicotra-gebhardt.com

Safety Instructions

The following warnings, cautions and notes are provided for your safety and has a means of preventing damage to the product or components at the connected machines. This section lists warnings, cautions and notes, which apply generally when handling the Nicotra Gebhardt driver, classified as **General, Transport & Storage, Commissioning, Operation and Repair.**

Specific warnings, cautions and notes that apply to particular activities are listed at the beginning of the relevant chapters and are repeated or supplemented at critical points throughout these sections.

Please read the information carefully, since it is provided for your personal safety and will also help prolonging the service life of your fan.

General



This equipment contains dangerous voltages and controls and potentially dangerous rotating mechanical parts. Non-compliance with these warnings or failure to follow the instructions contained in this manual can result in loss of life, severe personal injury or serious damage to property.

Only suitable qualified personnel should work on this equipment, and only after becoming familiar with all safety notices, installation, operation and maintenance procedures contained in this manual. The successful and safe operation of this equipment is dependent upon its proper handling, installation, operation and maintenance.

Children and the general public must be prevented from accessing or approaching the equipment!

Risk of electric shock! The DC-BUS capacitors remain charged after main supply has been switched off. It is not permissible to open the driver until 10 minutes after the main supply has been removed.



This equipment may only be used for the purpose specified by the manufacturer. Unauthorized modifications and the use of spare parts and accessories that are not sold or recommended by the manufacturer of the equipment can cause fires, electric shocks and injuries.

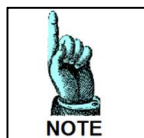

Keep these operating instructions within easy reach of the equipment and make them available to all users. Whenever measuring or testing has to be performed on live equipment suitable electronic tools should be used.

Before installing and commissioning, please read these safety instructions and warnings carefully and all the warning labels attached to the equipment.

Make sure that the warning labels are kept in a legible condition and replace missing or damaged labels.

Transport & Storage



Correct transport, storage, erection and mounting, as well as careful operation and maintenance are essential for proper and safe operation of the equipment.



Protect the fan against physical shocks and vibration during transport and storage. Also be sure to protect it against water (rainfall) and excessive temperatures.



If the fan must be subject to long-term storage, the storage time without application of any power supply shall not exceed two years since fan production or since operating the fan for at least half-an-hour continuously. The storage site shall have a temperature between -20°C and +70 °C, a Relative Humidity lower than 75%, and not be subject to condensation or exposed to dust.

Commissioning



Work on the device/system by unqualified personnel or failure to comply with warnings can result in severe personal injury or serious damage to material.

Only suitably qualified personnel trained in the setup, installation, commissioning and operation of the product should carry out work on the device/system.

This driver must be grounded.

The following terminals can carry dangerous voltages even if the driver is inoperative:

- *the power supply terminals L, N or R, S, T*
- *the motor terminals U, V, W*

Operation



Ensure correct grounding connections. The ground cable must be sufficient to carry the maximum supply fault current which normally will be limited by the fuses or MCB. Suitably rated fuses or MCB should be fitted in the main supply to the driver, according to any local legislation or codes.



The driver operates at high voltages.

Certain parameter settings may cause the driver to restart automatically after an input power failure.

Repair



Repairs on driver may only be carried out by Nicotra Gebhardt.

Before opening the driver for access, disconnect the power supply and wait for at least 10 minutes until the DC-BUS capacitor is completely discharged!

Ambient Operating Conditions



Protection Class: IP 44

Humidity Range: 90% non-condensing

Altitude: if the fan is to be installed at an altitude > 1000m, derating is required.

Shocks: do not drop the fan or expose it to sudden shock.

Vibration: do not install the fan in an area where it is likely to be exposed to constant vibrations.

CE conformity

Mechanical and Electrical safety

The EC drive systems which are covered by this catalogue are designed for incorporation in direct driven fans, fulfilling the requirements set by the **Machinery Directive (MD - Dir. 2006/42/EU)**, and also those parts of the **Low-Voltage Directive (Dir. 2014/35/EU)** which are applicable in accordance with the MD, where it concerns electrical safety.

Electrical safety is generally achieved by application of the provisions of the **EN 60204-1 standard “Electrical equipment of machines - General requirements”**.

Selected ranges may be designed to be suitable for incorporation (as components) within products which comply with the standards **EN 60335-1 “Household and similar electrical appliances - Safety - General requirements”** and **60335-2-40 “Household and similar electrical appliances - Safety - Particular requirements for electrical heat pumps, air-conditioners and dehumidifiers”**.

Such safety requirements are covered as far as necessary for a partly complete machine, sub-assembly or component, as these fans are specifically intended for incorporation within other machines.

The responsibility for the mechanical and electrical safety of the installed fan is thus of the manufacturer of the complete machine and, for this reason, it is strictly forbidden to put the fan in operation before the manufacturer of the machine has assessed and declared that the complete machine fulfils all the essential safety requirements set forth by the MD.

Please, check the Declaration of Incorporation which accompanies each product, or ask your Nicotra Gebhardt sales representative, for additional information.

Electro-Magnetic Compatibility (EMC)

Single-phase drive systems: PFP 1.35 kW, DDMP 1 kW, DDMP 2 kW, RDP 1 kW, RDP 2 kW, FDP 1 kW

The drivers of these products incorporate an Active Power Factor Control module, to provide harmonics filtering and compliance with the EMC requirements applicable to domestic and equivalent environments (“first environment”), or with the advanced requirements for harmonic distortion which often apply to data centres.

The resulting drive systems comply with C1-class levels for power-drive systems, according to **EN 61800-3 standard “Adjustable speed electrical power drive systems - EMC requirements and specific test methods”**.

More specifically: they comply with the requirements set in

EN 61000-3-2 – Electromagnetic compatibility (EMC). Part 3-2: Limits. Limits for harmonic current emissions (equipment input current $\leq 16A$ per phase).

EN 61000-3-3 – Electromagnetic compatibility (EMC). Part 3-3: Limitation of voltage changes, voltage fluctuations and flicker in public low-voltage supply systems, for equipment with rated current $\leq 16A$ per phase and not subject to conditional connection.

EN 61000-6-2 – Electromagnetic compatibility (EMC). Part 6-2: Generic standards. Immunity for industrial environments.

EN 61000-6-3 – Electromagnetic compatibility (EMC). Part 6-3: Generic standards. Emission standard for residential, commercial and light-industrial environments.

Three-phase drive systems: PFP 2.6 kW, DDMP 2.6 kW, RDP 2.6 kW

The drivers of these products are provided with basic EMI filters only.

The resulting drive systems comply with the EMC requirements for class C2 of power-drive systems, according to **EN 61800-3**. As such, they are suitable for use in the “first environment”, under condition that they are incorporated into an apparatus, system or installation, which is neither a plug-in device nor a movable device. Such devices shall have to be installed and commissioned only by a professional.

More specifically: they comply with the requirements set in

EN 61000-3-2 – Electromagnetic compatibility (EMC). Part 3-2: Limits. Limits for harmonic current emissions (equipment input current $\leq 16A$ per phase).

According to this standard, these devices are classified as “professional devices having total input power greater than 1 kW”. Direct connection to a low voltage supply (public networks) may be allowed insofar as this has been approved by the relevant energy distribution authority.

EN 61000-3-3 – Electromagnetic compatibility (EMC). Part 3-3: Limitation of voltage changes, voltage fluctuations and flicker in public low-voltage supply systems, for equipment with rated current $\leq 16A$ per phase and not subject to conditional connection.

EN 61000-6-2 – Electromagnetic compatibility (EMC). Part 6-2: Generic standards. Immunity for industrial environments.

EN 61000-6-4 – Electromagnetic compatibility (EMC). Part 6-4: Generic standards - Emission standard for industrial environments

which this product is incorporated must comply with the EMC Directive 2004/108/EC.

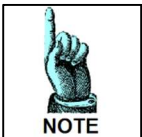

To improve the Electromagnetic compatibility a ferrite should be put on the power supply cable (close to the driver). The compliancy to the standards are intended for a single fan. No tests have been made on multiple installations.



The EMC tests are conducted without 485 communication wire, analog signals or Bluetooth devices

Safe Operating Area

The drivers are protected against overload conditions and a safe operating area is defined by a limit of speed, output power and motor current (see fig.1).

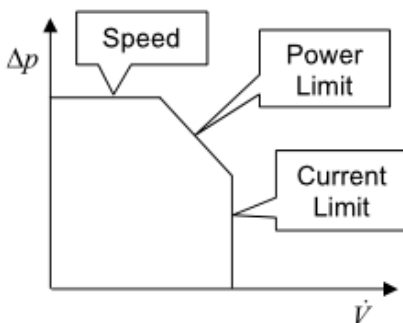
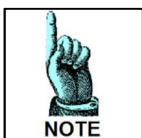

Fig. 1 – Safe Operating Area



This manual refers to fans having drivers with a firmware revision 5 or higher

PRODUCT OVERVIEW

General Information

The fans are equipped by an external permanent magnet rotor motor. The rotor magnets are made by rare earths (NdFeB) that strongly reduce the motor dimension and therefore the fan obstruction. The motor shape itself has been chosen for increasing the airflow inside the fan scroll.

The drivers are very compact or fully integrated into the motor and drive it through a sensorless algorithm.



FANS			
PFP	RDP	DDMP	FDP
			

Table 1





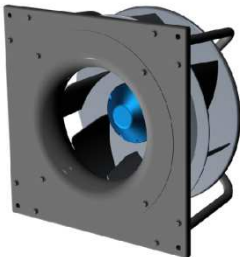

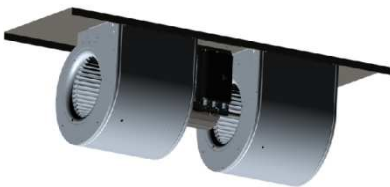



DRIVERS				
				
				
				
Single Phase - 1.35 kW	Three Phase – 2.65kW	Single Phase – 1.05kW	Single Phase – 2.1kW	Three Phase – 2.65kW

Table 2





MOTORS			
			
Flange external rotor motor Length stack: 25, 45, 60 mm Diameter: 138mm	Flange external rotor motor Length stack: 25, 45, 60 mm Diameter: 138mm	Double shaft external rotor motor Length stack: 25, 45, 60 mm Diameter: 138mm	Double shaft internal rotor motor

Table 3

CONNECTIONS



Work on the driver/fan by unqualified personnel or failure to comply with warnings can result in severe personal injury or serious damage to material.

Only suitably qualified personnel trained in the set-up, installation, commissioning and operation of the product should carry out work on the driver/fan. This driver must be grounded. The power supply terminals L, N (1-Phase) or R, S, T (3-Phase) and the motor terminals U, V, W can carry dangerous voltages even if the driver is inoperative

Power supply

The end user has to connect the power supply cable and the command signal to the control board, while the motor connection is already done by Nicotra | Gebhardt.

<p>PFP 1.35kW 1-Phase</p>		<p>Single Phase 220/240V ±10% @ 50/60Hz</p> <p>The performance in the range [200V-264V] @ 50Hz/60Hz is always the same due to the PFC module inside the driver!</p>
<p>PFP 2.65kW 3-Phase</p>		<p>Three Phase 400V ±10% @ 50/60Hz</p> <p>The performance in the range [360V-440V] @ 50Hz/60Hz could change depending on the fan size and the working point!</p>
<p>DDMP, RDP and FDP 1.05kW 1-Phase</p>		<p>Single Phase 220/240V ±10% @ 50/60Hz</p> <p>The performance in the range [200V-264V] @ 50Hz/60Hz is always the same due to the PFC module inside the driver!</p>
<p>DDMP, RDP 2.1kW 1-Phase</p>		<p>Single Phase 220/240V ±10% @ 50/60Hz</p> <p>The performance in the range [200V-264V] @ 50Hz/60Hz is always the same due to the PFC module inside the driver!</p>
<p>DDMP, RDP 2.65kW 3-Phase</p>		<p>Three Phase 400V ±10% @ 50/60Hz</p> <p>The performance in the range [360V-440V] @ 50Hz/60Hz could change depending on the fan size and the working point!</p>

Table 4

Control Board connection

In the Table 5 are shown the signal connections for each EC fan model

FAN	Control Board	Terminal block	Diagram
PFP 1.35 kW 1-Phase		 10 poles	 TACHO/ALARM/FILTER
PFP 2.65 kW 3-Phase		 10 poles	 TACHO/ALARM/FILTER
DDMP, RDP and FDP 1.05 kW 1-Phase		 7 poles	 TACHO/ALARM/FILTER
DDMP, RDP 2.1 kW 1-Phase		 9 Poles	 TACHO/ALARM/FILTER
DDMP, RDP 2.65 kW 3-Phase		 10 Poles	 TACHO/ALARM/FILTER

Table 5



**Don't reverse the input signal or connect the +10V, 12V or +24V to signal ground.
The driver could be damaged.**

Don't apply signals with voltage outside the indicated limits, the driver could be damaged.

Connection details

In this chapter are explained the feature and the possible connection of the control board of each model. The control board terminals are opto-insulated.



The available features can be different depending on the fan model.

Analog		Feature available on
<p>This is the driver default mode and the signal must be connected into the ANALOG INPUT and the reference to GND.</p>  <p>The analog input can accept also a PWM signal with $f > 1\text{kHz}$</p> <p>Don't use devices having the signal GND connected to the NEUTRAL cable of the power supply. The driver may be damaged or not functioning properly.</p> <p>The +10V power supply available of the driver is intended to be used with a potentiometer of minimum 2KOhm, with a max absorbed current of 5mA.</p> <p>Any different devices connected to it could bring to an undesired functioning of the driver or of connected device.</p> <p>Nicotra Gebhardt can provide a dedicated potentiometer: REGPOT code K43138 (with stop function or without).</p>		<p>ALL FANS</p>
		
<p>If two or more fans are installed in the same compartment, they can be connected in parallel. In this configuration the fans start and stop at the same time.</p>  <p>An auto-restarting alarm occurs when a fan is forced to run forward (or backward) rotation with a speed higher than 150 rpm.</p>		
<p>It is necessary to add a 0.1% precision resistances between the ANALOG INPUT and GND if an ext. 4-20mA device is used.</p> <p>The value of the resistance can range from:</p> <p>125 Ω \rightarrow V_{signal} ranges from 0.5V to 2.5V</p> <p>to 500 Ω \rightarrow V_{signal} ranges from 2V to 10V</p>		

Table 6





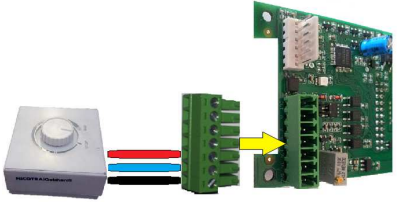
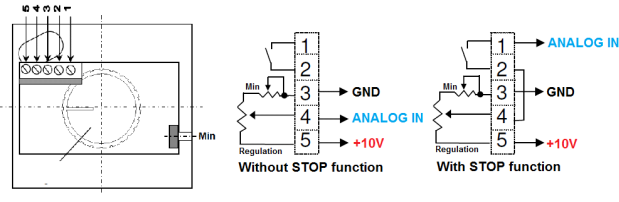
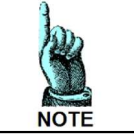
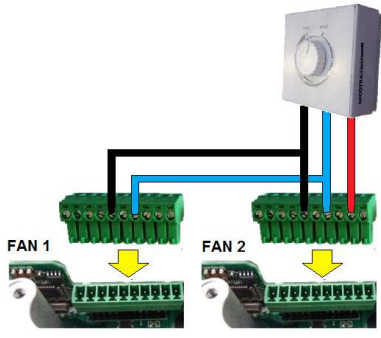
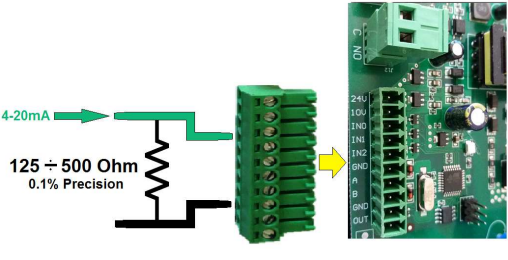

Modbus Communication		Feature available on																																									
<p>A Modbus RTU protocol is available on all the fan models. The line must be connected to MODBUS-A, MODBUS-B and GND pins. There are two possible Modbus connections:</p> <ol style="list-style-type: none"> 1) During the fan functioning through a RS-485 serial connection 2) With the driver powered off through a RS-232 serial connection 		<p>ALL FANS</p>																																									
<p>To connect the driver to a PC during the fan functioning, an USB to 485 converter can be used; for example a FTDI cable: USB-RS485-WE-1800-BT.</p> 																																											
<p>To connect OFFLINE the driver to a PC when the fan is powered off, an USB to RS232 converter can be used; for example a FTDI cable: TTL-232R-5V-WE. A MOLEX connector is necessary to connect the cable to the driver.</p>  <div style="display: flex; justify-content: space-around; align-items: center;"> <div style="text-align: center;"> <p>MOLEX 08-50-0032</p>  </div> <div style="text-align: center;"> <p>MOLEX 22-01-2075</p>  </div> </div>	<div style="display: flex; justify-content: space-around;"> <div style="text-align: center;"> <p>7 6 5 4 3 2 1</p>   <table border="1" style="margin: 0 auto;"> <tr><td>0</td><td>0</td><td>0</td><td>0</td><td>0</td><td>0</td><td>0</td></tr> <tr><td>7</td><td>6</td><td>5</td><td>4</td><td>3</td><td>2</td><td>1</td></tr> <tr><td>GND</td><td>RESET</td><td>TX</td><td>RX</td><td>+5V</td><td>BOOT</td><td></td></tr> </table> <p>3-Phase Driver</p> </div> <div style="text-align: center;"> <p>7 6 5 4 3 2 1</p>   <table border="1" style="margin: 0 auto;"> <tr><td>0</td><td>0</td><td>0</td><td>0</td><td>0</td><td>0</td><td>0</td></tr> <tr><td>7</td><td>6</td><td>5</td><td>4</td><td>3</td><td>2</td><td>1</td></tr> <tr><td>GND</td><td>MODE</td><td>TX</td><td>RX</td><td>+5V</td><td>BOOT</td><td></td></tr> </table> <p>1-Phase Driver</p> </div> </div>		0	0	0	0	0	0	0	7	6	5	4	3	2	1	GND	RESET	TX	RX	+5V	BOOT		0	0	0	0	0	0	0	7	6	5	4	3	2	1	GND	MODE	TX	RX	+5V	BOOT
0	0	0	0	0	0	0																																					
7	6	5	4	3	2	1																																					
GND	RESET	TX	RX	+5V	BOOT																																						
0	0	0	0	0	0	0																																					
7	6	5	4	3	2	1																																					
GND	MODE	TX	RX	+5V	BOOT																																						
 <p>NOTE</p>	<p>Specifications and drivers can be downloaded from FTDI web site. http://www.ftdichip.com</p>																																										

Table 7

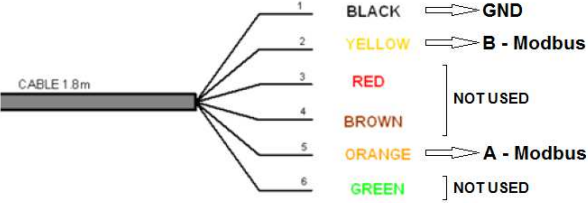
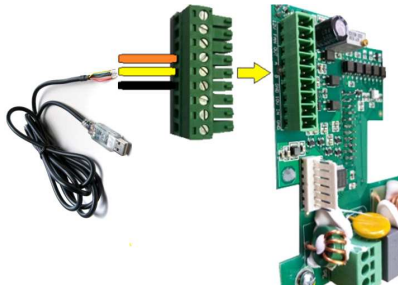
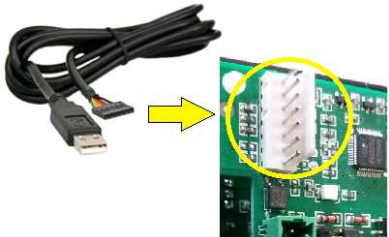
Enable Signal		Feature available on
<p>The ENABLE function is present only on few models. The fan runs when the ENABLE input is bridged to the +10V or +24V power supply</p>  <p>NOTE</p> <p><i>The status of the ENABLE input doesn't affect the Modbus Temporary.</i></p>		<p>PFP 1.35kW, 1-Ph</p> <p>PFP 2.65kW, 3-Ph</p> <p>DDMP 2.65kW, 3-Ph</p> <p>RDP 2.65kW, 3-Ph</p>

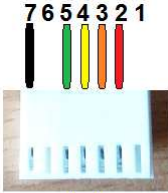
Table 8

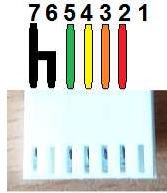
Transducer Input		Feature available on
<p>An external transducer can be powered and connected to the driver.</p> <p>There are two possible connections depending on the kind of transducer used:</p> <ol style="list-style-type: none"> 1) Open Control Loop Transducer 2) Closed Control Loop Transducer <p>Nicotra Gebhardt can provide a Pressure Transducer code 143198 that can work both in open and closed loop.</p>		<p>PFP 1.35kW, 1-Ph</p> <p>PFP 2.65kW, 3-Ph</p> <p>DDMP 2.65kW, 3-Ph</p> <p>RDP 2.65kW, 3-Ph</p>
<p>If the transducer doesn't have its own control and it supplies a voltage signal [0, +10V] proportional to the measured variable, it is possible to use the tunable PID of the driver. The signal must be connected to the TRANSDUCER INPUT.</p>	<p>If the transducer has its own PID control, the signal must be connected to the standard ANALOG INPUT</p>	
		

Table 9

+24V AUX Power supply		Feature available on
<p>The +24V out can supply a max current of 50mA and it's able to drive the Nicotra Gebhardt pressure transducer code 143198.</p> <p>Use an available ground pin on the board for powering devices.</p>		<p>PFP 2.65kW, 3-Ph</p> <p>DDMP 2.65kW, 3-Ph</p> <p>RDP 2.65kW, 3-Ph</p>
		

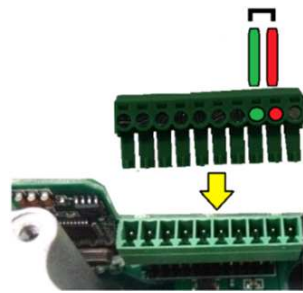
Table 10

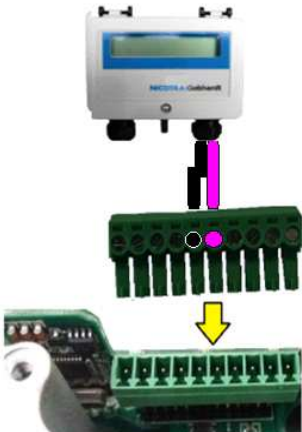
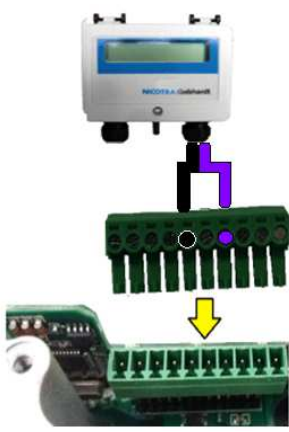

+12V AUX Power supply		Feature available on
<p>An auxiliary power supply of 12V is available on the 2.1kW Single-Phase drivers.</p> <p>The max current absorbed must be lower than 200mA.</p> <p>Use an available ground pin on the board for powering devices.</p>		<p>DDMP 2.1kW, 1-Ph</p> <p>RDP 2.1kW, 1-Ph</p>
 <p>NOTE</p> <p><i>This power is not stabilized and it decreases when the current absorption exceeds the above indicated limit.</i></p> <p><i>The FAN pin is not active</i></p>		

Table 11

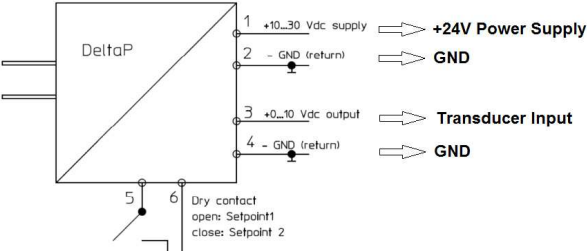
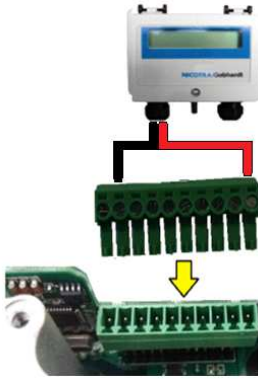
Relay		Feature available on
<p>An relay is available on the Three-Phase drivers.</p> <p>It is suitable for 250Vac/30Vdc 5A.</p>		<p>PFP 2.65kW, 3-Ph</p> <p>DDMP 2.65kW, 3-Ph</p> <p>RDP 2.65kW, 3-Ph</p>
 <p>NOTE</p> <p><i>When the driver is powered off the relay is open → the PCB label indicates C-NO.</i></p> <p><i>During the functioning the relay is Normally Closed in No-Alarm condition and open in case of alarm.</i></p>		

Table 12

Tachometric, Alarm and Filter Output		Feature available on
<p>The tachometric output is a 0 to 10V PWM waveform at 1KHz with the following duty cycle:</p> <p>Duty Cycle (Speed) = $10\% + \frac{90\% \cdot (\text{Speed}_{\text{Real}} - \text{Speed}_{\text{min}})}{\text{Speed}_{\text{MAX}} - \text{Speed}_{\text{min}}}$ when the speed is equal or higher than the speed min and it is 0% when the speed is lower.</p> <p>The device reading the output must be connected to TACHO\ALARM\FILTER pin and GND.</p> <p>The max current supplied of the output is 0.2mA.</p>		<p>ALL FANS</p>
 <p>NOTE</p> <p><i>Remember that the Speed_{Real} is 0 below Speed_{min} unless the fan is in the dragging phase.</i></p>		

Table 13

Input Impedances		Feature available on
ENABLE ANALOG INPUT TRANSDUCER INPUT	200 kΩ	PFP 1.35 kW 1-Phase
ENABLE ANALOG INPUT TRANSDUCER INPUT	200 kΩ	PFP 2.65 kW 3-Phase
ANALOG INPUT	20 kΩ	DDMP, RDP and FDP 1.05 kW 1-Phase
ANALOG INPUT	200 kΩ	DDMP, RDP 2.1 kW 1-Phase
ENABLE ANALOG INPUT TRANSDUCER INPUT	200 kΩ	DDMP, RDP 2.65 kW 3-Phase

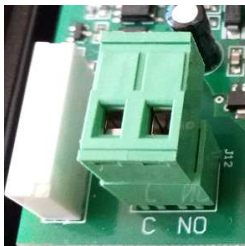
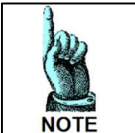
Table 14

OPERATING MODES AND SETTING OPTIONS

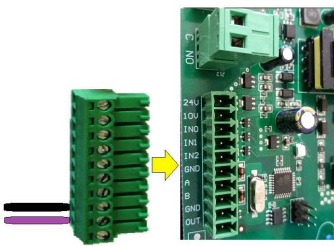
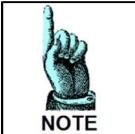
Depending on the fan model there are 4 possible **Operating Modes** and for each mode 3 possible **Setting Options**

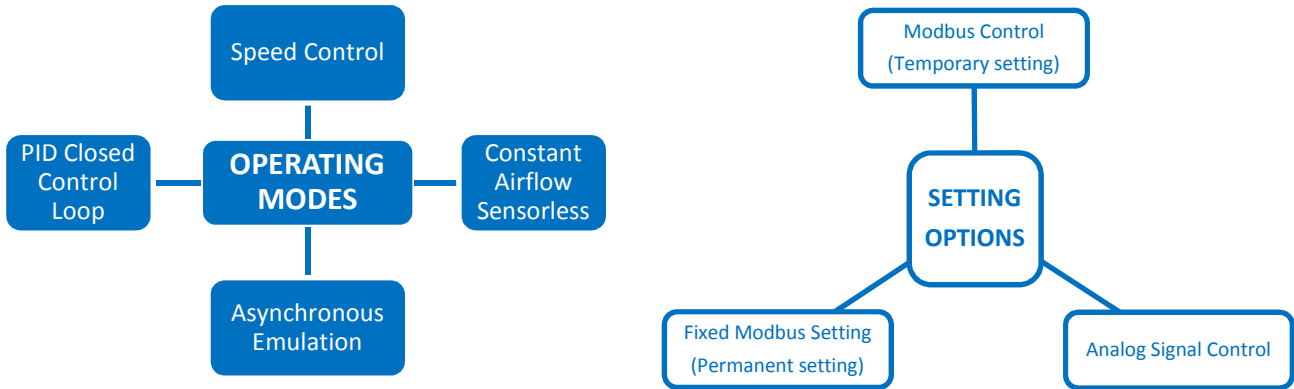

Fig. 2 – Operating Modes and Setting Options

The operating modes and the setting options can be chosen by modifying the INPUT TYPE Holding Register 34

Speed Control

Analog Speed Control

Feature Availability								
DDMP			RDP			PFP		FDP
1-Phase		3-Phase	1-Phase		3-Phase	1-Phase	3-Phase	1-Phase
1.05kW	2.1kW	2.65kW	1.05kW	2.1kW	2.65kW	1.35kW	2.65kW	1.05kW
✓	✓	✓	✓	✓	✓	✓	✓	✓

(INPUT TYPE = 1 Default factory setting)

Through this setting the fan speed is proportional to the analog voltage input. The fan speed is limited by the Safe Operating Area, therefore, depending on the fan working point, the fan could be no more able to increase the speed coherently to the set voltage value.

To avoid the loss of signal dynamic, a speed limit rescaling is necessary by modifying the value of the Max Speed Holding Register 2 . It is also possible to rescale the min Speed by modifying the Holding Register 1 .

The analog signal can be read from the Input Register 14 .

The MAX and min speed default values are in function of the fan sizes .

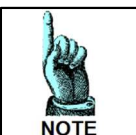

The minimum speed holding register can't be modified for some fan model → Refer to the table below

DDMP			RDP			PFP		FDP
1-Phase		3-Phase	1-Phase		3-Phase	1-Phase	3-Phase	1-Phase
1.05kW	2.1kW	2.65kW	1.05kW	2.1kW	2.65kW	1.35kW	2.65kW	1.05kW
✓	✓	✓	✗	✗	✓	✗	✓	✗

Modbus Temporary Speed Control

Feature Availability								
DDMP			RDP			PFP		FDP
1-Phase		3-Phase	1-Phase		3-Phase	1-Phase	3-Phase	1-Phase
1.05kW	2.1kW	2.65kW	1.05kW	2.1kW	2.65kW	1.35kW	2.65kW	1.05kW
✔	✔	✔	✔	✔	✔	✔	✔	✔

(INPUT TYPE = 0)

Through this setting the fan runs at the speed defined by modifying the Holding Register 66 .
The setting is maintained meanwhile the fan is powered on and it is lost when the fan is powered off.

Modbus Fixed Speed Control

Feature Availability								
DDMP			RDP			PFP		FDP
1-Phase		3-Phase	1-Phase		3-Phase	1-Phase	3-Phase	1-Phase
1.05kW	2.1kW	2.65kW	1.05kW	2.1kW	2.65kW	1.35kW	2.65kW	1.05kW
✔	✔	✔	✔	✔	✔	✔	✔	✔

(INPUT TYPE = 2)

Through this setting the fan runs at the speed defined by modifying the Holding Register 21 .
The setting is permanent and fan starts at the defined speed each time it is powered on.

Speed Control curves example

In figure 3 it is shown a set of performance curves at different speed settings limited by the fan max working limit curve (see Safe Operating Area)

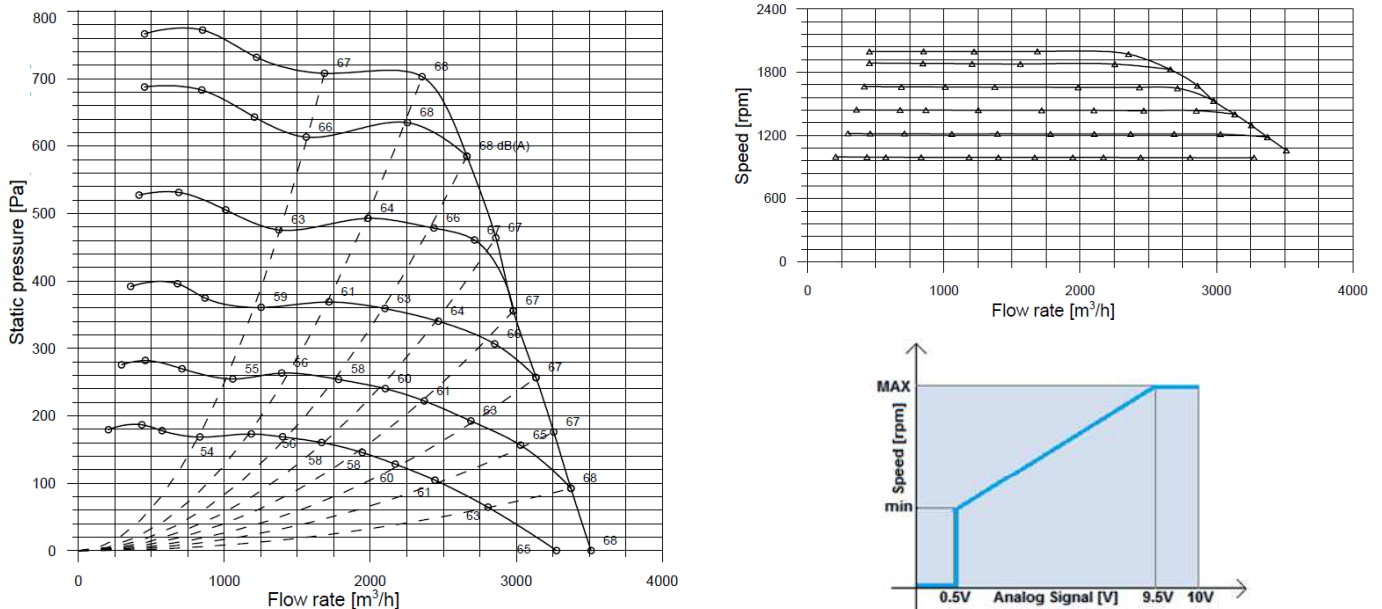

Fig.3 – Speed control curves and voltage law

Constant Airflow

Through this mode a Constant Airflow is maintained without any external pressure transducer. This is obtained through a dedicated algorithm loaded into the microcontroller of the driver.

Analog Constant Airflow

Feature Availability								
DDMP			RDP			PFP		FDP
1-Phase		3-Phase	1-Phase		3-Phase	1-Phase	3-Phase	1-Phase
1.05kW	2.1kW	2.65kW	1.05kW	2.1kW	2.65kW	1.35kW	2.65kW	1.05kW

(INPUT TYPE = 4)

Through this setting the constant airflow is proportional to the analog voltage input. Each fan has default lower and higher limit for the constant airflow curves that can be increased by modifying the [Holding Register 42](#) and the [Holding Register 43](#).

The choice of reducing the Constant Airflow Range is depending on the user application and it is especially useful when the application must guarantee a defined minimum constant airflow.

The selectable airflows are restricted to a defined range for each fan size.

The lower limit avoids big deviations from the constant airflow while the high limits are determined by the Safe Operating Area.

Modbus Temporary Constant Airflow

Feature Availability								
DDMP			RDP			PFP		FDP
1-Phase		3-Phase	1-Phase		3-Phase	1-Phase	3-Phase	1-Phase
1.05kW	2.1kW	2.65kW	1.05kW	2.1kW	2.65kW	1.35kW	2.65kW	1.05kW

(INPUT TYPE = 5)

Through this setting the fan runs at the constant airflow defined by modifying the [Holding Register 66](#).

The setting is maintained meanwhile the fan is powered on and it is lost when the fan is powered off.

Modbus Fixed Constant Airflow

Feature Availability								
DDMP			RDP			PFP		FDP
1-Phase		3-Phase	1-Phase		3-Phase	1-Phase	3-Phase	1-Phase
1.05kW	2.1kW	2.65kW	1.05kW	2.1kW	2.65kW	1.35kW	2.65kW	1.05kW

(INPUT TYPE = 6)

Through this setting the fan runs at the constant airflow defined by modifying the [Holding Register 39](#).

The setting is permanent and fan starts at the defined constant airflow each time it is powered on.

Constant Airflow curves example

In figure 4 are shown 6 constant airflow curves randomly chosen and the relationship between the voltage signal and the corresponding airflow.

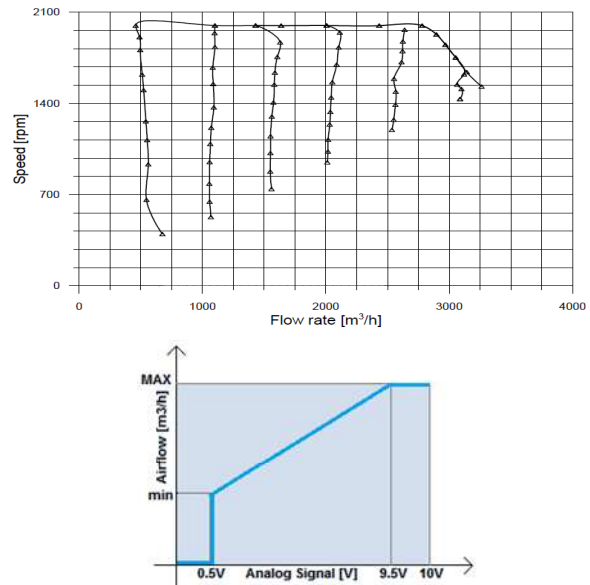
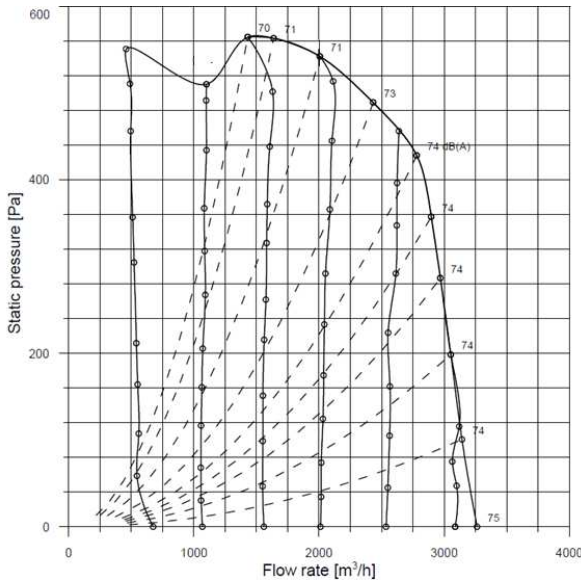
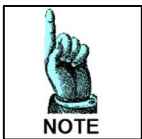

Fig.4 – Constant Airflow curves and voltage law



NOTE

The driver microcontroller elaborates only speed and current data to obtain the constant performance, but it cannot recognize airflow and static pressure values. Therefore these values are not available in the driver Input Registers. The max resolution from on constant airflow to another is +/-50m3/h. The max precision guaranteed is SET AIRFLOW +/- 100 m3/h In the instability areas typical of some fan sizes the constant airflow precision can't be guaranteed. It's anyway suggested to work outside these areas.

Asynchronous Emulation

Feature Availability								
DDMP			RDP			PFP		FDP
1-Phase		3-Phase	1-Phase		3-Phase	1-Phase	3-Phase	1-Phase
1.05kW	2.1kW	2.65kW	1.05kW	2.1kW	2.65kW	1.35kW	2.65kW	1.05kW
✓	✓	✓	✗	✗	✗	✗	✗	✓

Through this mode there is the possibility to emulate the behavior of an asynchronous induction motor with a slip and a power limitation dependent on the load and speed (therefore there could be some differences from each size). The control is expressed in percentage instead of a defined measure unit. The lower is the slip the higher is the performance and vice versa.

Analog Asynchronous Emulation

Feature Availability								
DDMP			RDP			PFP		FDP
1-Phase		3-Phase	1-Phase		3-Phase	1-Phase	3-Phase	1-Phase
1.05kW	2.1kW	2.65kW	1.05kW	2.1kW	2.65kW	1.35kW	2.65kW	1.05kW
✓	✓	✓	✗	✗	✗	✗	✗	✓

(INPUT TYPE = 7)

Through this setting the slip is proportional to the analog voltage.

Modbus Temporary Asynchronous Emulation

Feature Availability								
DDMP			RDP			PFP		FDP
1-Phase		3-Phase	1-Phase		3-Phase	1-Phase	3-Phase	1-Phase
1.05kW	2.1kW	2.65kW	1.05kW	2.1kW	2.65kW	1.35kW	2.65kW	1.05kW
✓	✓	✓	✗	✗	✗	✗	✗	✓

(INPUT TYPE = 8)

Through this setting the fan emulates an ACIM motor and the slip is defined by modifying the Holding Register 66. The setting is maintained meanwhile the fan is powered on and it is lost when the fan is powered off.

Modbus Fixed Asynchronous Emulation

Feature Availability								
DDMP			RDP			PFP		FDP
1-Phase		3-Phase	1-Phase		3-Phase	1-Phase	3-Phase	1-Phase
1.05kW	2.1kW	2.65kW	1.05kW	2.1kW	2.65kW	1.35kW	2.65kW	1.05kW
✓	✓	✓	✗	✗	✗	✗	✗	✓

(INPUT TYPE = 9)

Through this setting the fan emulates an ACIM motor and the slip is defined by modifying the Holding Register 30. The setting is permanent and fan starts at the defined constant slip each time it is powered on.

Asynchronous Emulation curves example

In figure 5 are shown 5 curves with the following slip percentage: 100%, 80%, 60%, 40% and 20%

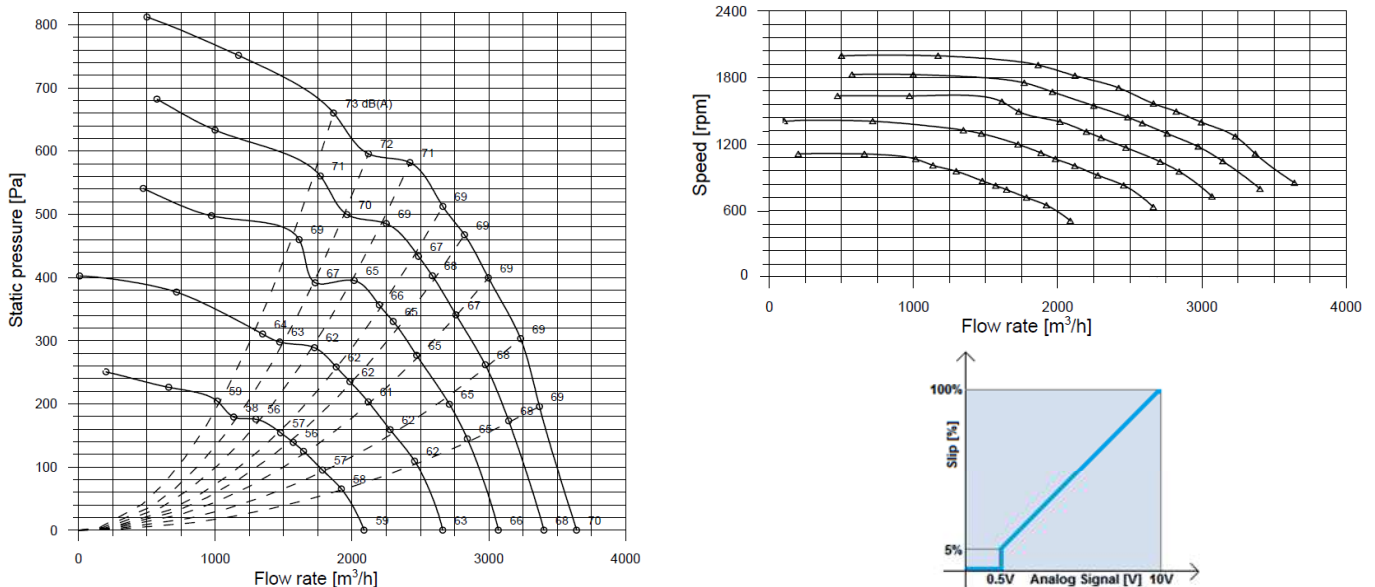
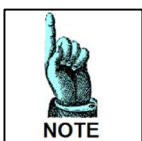

Fig.5 – Asynchronous Emulation curves and voltage law



The slip has not a physical meaning and must be intended as a 100% full performance and 0% fan stop.

PID Closed Control Loop

Through this setting the fan is able to work in a PID closed control loop where the measured process variable is connected to the TRANSDUCER INPUT that can be monitored through the [Input Register 31](#).

and it must be in the range of [0,10V].

The PID mode can be therefore used with temperature probes, pressure transducer, CO/CO₂ detectors, etc.

The parameters to set are:

- K_p = Proportional Gain [Holding Register 51](#)
- K_I = Integral Gain [Holding Register 52](#)
- K_D = Derivative Gain [Holding Register 53](#)
- $Time = T_{PID}$ [Holding Register 54](#)

Here below the simplified PID code:

$$Error = (R_{reference} - M_{easure}); \quad P_{roportional} = K_p \cdot Error;$$

$$I_{ntegral} + = K_I \cdot Error \cdot T_{PID};$$

$$D_{erivative} = \frac{K_D (Error_n - Error_{n-1})}{T_{PID}};$$

$$Error_{n-1} = Error_n;$$

$$R_{esult} = P_{roportional} + I_{ntegral} + D_{erivative};$$

Analog ref. PID Closed Control Loop

In this mode the PID reference is given by the analog signal present at the ANALOG INPUT that can be monitored through the [Input Register 29](#).

Feature Availability								
DDMP			RDP			PFP		FDP
1-Phase		3-Phase	1-Phase		3-Phase	1-Phase	3-Phase	1-Phase
1.05kW	2.1kW	2.65kW	1.05kW	2.1kW	2.65kW	1.35kW	2.65kW	1.05kW

(INPUT TYPE = 10)

Modbus Temporary ref. PID Closed Control Loop

Feature Availability								
DDMP			RDP			PFP		FDP
1-Phase		3-Phase	1-Phase		3-Phase	1-Phase	3-Phase	1-Phase
1.05kW	2.1kW	2.65kW	1.05kW	2.1kW	2.65kW	1.35kW	2.65kW	1.05kW

(INPUT TYPE = 11)

In this mode the PID reference is defined by modifying the [Holding Register 66](#).

The value of the reference is expressed in steps of 0.1Volt (therefore the register ranges from 0 to 100)

The PID error is calculated in the following way:

$$Error = (Modbus_{REG_66} - ANALOG_{Input})$$

Modbus Fixed ref. PID Closed Control Loop

Feature Availability								
DDMP			RDP			PFP		FDP
1-Phase		3-Phase	1-Phase		3-Phase	1-Phase	3-Phase	1-Phase
1.05kW	2.1kW	2.65kW	1.05kW	2.1kW	2.65kW	1.35kW	2.65kW	1.05kW
✓	✓	✓	✓	✓	✓	✓	✓	✓

(INPUT TYPE = 12)

Through this mode the PID reference is defined by modifying the Holding Register 50 .

The value of the reference is expressed in units of 0.1Volt (therefore the register ranges from 0 to 100)

The PID error is calculated in the following way:

$$Error = (Modbus_{REG_50} - ANALOG_{Input})$$

Modbus Positive/Negative feedback

Depending on the application it could be necessary to invert the feedback behavior (Fig.24).

Through the Holding Register 31 it is possible to multiply by -1 the PID error.

When the register is set to 0 $\rightarrow Error = (R_{eference} - M_{easure})$;

When the register is set to 1 $\rightarrow Error = (M_{easure} - R_{eference})$;

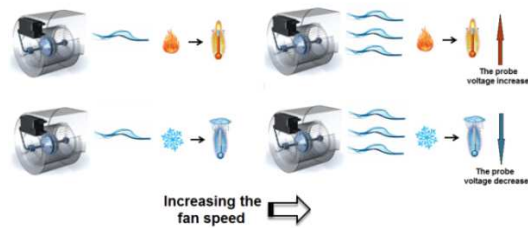

Fig. 6 – Example of positive/negative feedback coefficient

Changing the Operation Mode

Feature Availability								
DDMP			RDP			PFP		FDP
1-Phase		3-Phase	1-Phase		3-Phase	1-Phase	3-Phase	1-Phase
1.05kW	2.1kW	2.65kW	1.05kW	2.1kW	2.65kW	1.35kW	2.65kW	1.05kW
✓	✓	✓	✓	✓	✓	✓	✓	✓

Here in Table 15 are shown the actions passing from one Operation Mode to another one.

Action	Actions A	Actions B
Temporary Setting \rightarrow Fixed Setting	The fan must follow the target corresponding to the value stored the related register.	Fan is put in stop mode and after the data are saved the fan follows the target corresponding to the value stored into the related register.
Fixed Setting \rightarrow Temporary Setting	The fan must stop waiting for a new register 66 value.	The fan must stop waiting for a new register 66 value.
Temporary Setting \rightarrow Analog Signal	The fan must follow the target corresponding to the analog value at the inputs.	Fan is put in stop mode and after the data are saved the fan follows the target corresponding to the analog value.
Analog Signal \rightarrow Temporary Setting	The fan must stop waiting for a new register 66 value.	The fan must stop waiting for a new register 66 value.
Fixed Setting \rightarrow Analog Signal	The fan must follow the target corresponding at the analog value at the inputs.	Fan is put in stop mode and after the data are saved the fan follows the target corresponding to the analog value.
Analog Signal \rightarrow Fixed Setting	The fan must follow the target corresponding to the value stored the related register.	Fan is put in stop mode and after the data are saved the fan follows the target corresponding to the value stored into the related register.

Table 15

OTHER FEATURES

The EC-Fans have several **Other Features** as shown in fig.7.

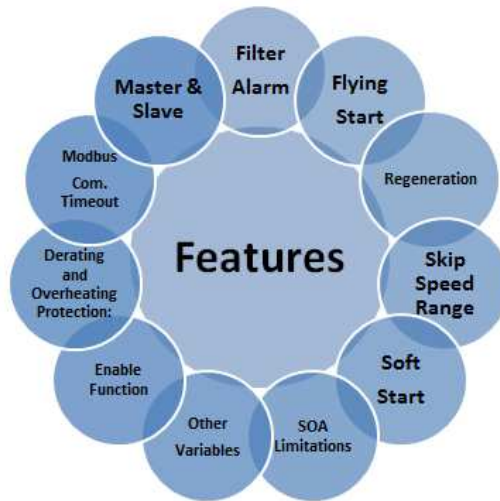

Fig. 7 – Other features

Filters Alarm

Feature Availability								
DDMP			RDP			PFP		FDP
1-Phase		3-Phase	1-Phase		3-Phase	1-Phase	3-Phase	1-Phase
1.05kW	2.1kW	2.65kW	1.05kW	2.1kW	2.65kW	1.35kW	2.65kW	1.05kW
✓	✓	✓	✓	✓	✓	✓	✓	✓

This feature is useful when the speed of the fan is not directly set by the user as fans set in Constant Airflow Asynchronous Emulation or PID mode.

The alarm is active when a speed threshold is overtaken.

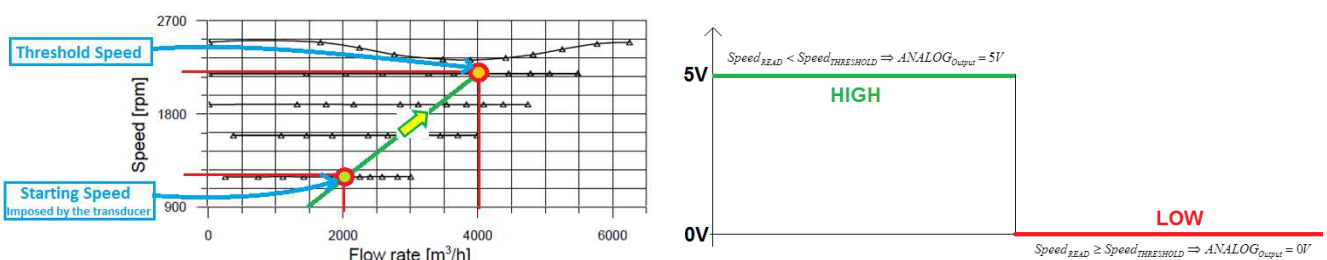

Fig. 8 – Speed threshold overtaken when an external transducer drives the fan

To activate this feature the Holding Register 46 must be set at value 2 and then the required Speed Threshold value must be set into the Holding Register 55. The digital output of the driver changes its status as shown in the fig 8.

Flying Start

Feature Availability								
DDMP			RDP			PFP		FDP
1-Phase		3-Phase	1-Phase		3-Phase	1-Phase	3-Phase	1-Phase
1.05kW	2.1kW	2.65kW	1.05kW	2.1kW	2.65kW	1.35kW	2.65kW	1.05kW
✗	✗	✓	✗	✗	✓	✗	✓	✗

The algorithm is able to catch the position of the rotor after changing the target speed to 0 and to a new value in short time. If too long time passed and the fan runs at very low speed it is not possible to catch the speed and the fan brake and restarts.

Regeneration

Feature Availability								
DDMP			RDP			PFP		FDP
1-Phase		3-Phase	1-Phase		3-Phase	1-Phase	3-Phase	1-Phase
1.05kW	2.1kW	2.65kW	1.05kW	2.1kW	2.65kW	1.35kW	2.65kW	1.05kW
✗	✗	✓	✗	✗	✓	✗	✓	✗

The algorithm is able to catch the position of the rotor after powering OFF and then ON the fan. If too long time passed and the fan runs at very low speed it is not possible to catch the speed and the fan brake and restarts.

Skip Speed Range

Feature Availability								
DDMP			RDP			PFP		FDP
1-Phase		3-Phase	1-Phase		3-Phase	1-Phase	3-Phase	1-Phase
1.05kW	2.1kW	2.65kW	1.05kW	2.1kW	2.65kW	1.35kW	2.65kW	1.05kW
✗	✗	✓	✗	✓	✓	✓	✓	✗

This feature allows to skip the resonance frequencies of the fan.

To activate this feature the [Holding Register 32](#) must be set at the desired [Avoid Range Start](#) and the [Holding Register 33](#) the desired [Avoid Range End](#).

$$Speed_{SET} \leq \frac{AR_{Start} - AR_{End}}{2} \Rightarrow Speed_{target} = AR_{Start}$$

$$Speed_{SET} > \frac{AR_{Start} - AR_{End}}{2} \Rightarrow Speed_{target} = AR_{End}$$

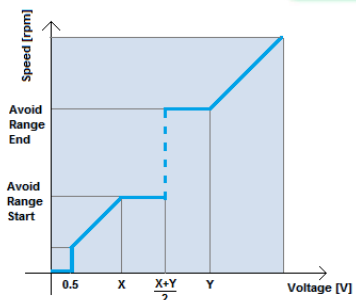

Fig. 9 – Skip Speed Range behavior

Soft Start

Feature Availability								
DDMP			RDP			PFP		FDP
1-Phase		3-Phase	1-Phase		3-Phase	1-Phase	3-Phase	1-Phase
1.05kW	2.1kW	2.65kW	1.05kW	2.1kW	2.65kW	1.35kW	2.65kW	1.05kW
✓	✓	✓	✓	✓	✓	✓	✓	✓

In the following paragraph the starting phase of a fan is shown.

- The first phase when the fan receives a command to start running is the ALIGNMENT. During this phase the driver aligns the rotor.
- The second phase is the dragging phase, where the fan gradually increases its speed to the minimum in open loop. In this phase the current and speed values present in the Input Register can't be taken in consideration.
- The last phase is the closed loop where the sensorless control is active and from the minimum speed to the target speed the fan accelerates with different ramps basing on the fan size and the wheel inertia. The acceleration and deceleration values are different and in particular to avoid overvoltage alarm or loss of synchronism alarm, the deceleration is always lower.

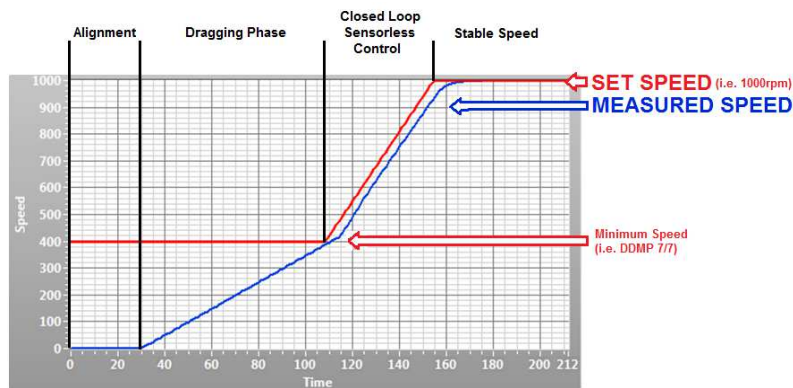

Fig. 10 – Starting phase of a EC fan

SOA Limitations

Speed Limitation

Availability									
DDMP			RDP			PFP		FDP	
1-Phase		3-Phase	1-Phase		3-Phase	1-Phase	3-Phase	1-Phase	
1.05kW	2.1kW	2.65kW	1.05kW	2.1kW	2.65kW	1.35kW	2.65kW	1.05kW	
✓	✓	✓	✓	✓	✓	✓	✓	✓	

The speed limits can be adjusted for the signal rescaling, but also to limit the noise in the final application.

The [Input Register 2](#) indicates the Speed Reference (minimum speed during alignment and dragging and the Set Speed in Closed Control Loop). The [Input Register 3](#) indicates the Measured Speed.

Power Limitation

Availability									
DDMP			RDP			PFP		FDP	
1-Phase		3-Phase	1-Phase		3-Phase	1-Phase	3-Phase	1-Phase	
1.05kW	2.1kW	2.65kW	1.05kW	2.1kW	2.65kW	1.35kW	2.65kW	1.05kW	
✓	✓	✓	✓	✓	✓	✓	✓	✓	

The driver is set by factory default to the max achievable power out to the motor depending on the model. During the functioning it is possible to monitor the power absorption by reading the [Input Register 31](#). If for some application it is necessary to keep the absorption of the fan below a defined power value, it is possible to reduce the max power out by modifying the [Holding Register 36](#).

Output Current Limitation

Availability									
DDMP			RDP			PFP		FDP	
1-Phase		3-Phase	1-Phase		3-Phase	1-Phase	3-Phase	1-Phase	
1.05kW	2.1kW	2.65kW	1.05kW	2.1kW	2.65kW	1.35kW	2.65kW	1.05kW	
✓	✓	✓	✓	✓	✓	✓	✓	✓	✓

The drivers are set by factory default to the max peak motor current out that changes depending on the motor windings characteristics.

During the functioning it is possible to read the peak motor current to the motor by reading the [Input Register 12](#).

It is possible to reduce the motor current by modifying the [Holding Register 7](#). It is suggested to keep the motor current above 3500mA.

Input Current Limitation

Availability									
DDMP			RDP			PFP		FDP	
1-Phase		3-Phase	1-Phase		3-Phase	1-Phase	3-Phase	1-Phase	
1.05kW	2.1kW	2.65kW	1.05kW	2.1kW	2.65kW	1.35kW	2.65kW	1.05kW	
✗	✗	✗	✗	✗	✗	✓	✗	✗	

Only the PFP single Phase has a input current limit of 5.9A. At 230V the driver is able to supply a power output of 1350W. Decreasing the input voltage, a derating occurs both for input and output current:

$$P_{In} = V_{PowerSupply} \cdot I_{InputCurrent} \quad \text{and} \quad P_{Out} = P_{In} \cdot \eta_{fan}$$

During the functioning it is possible to monitor the input current by reading the [Input Register 32](#).

Other Variables

There are other variables that can be monitored for a safe use of the fan.

Bus Voltage

Availability									
DDMP			RDP			PFP		FDP	
1-Phase		3-Phase	1-Phase		3-Phase	1-Phase	3-Phase	1-Phase	
1.05kW	2.1kW	2.65kW	1.05kW	2.1kW	2.65kW	1.35kW	2.65kW	1.05kW	
✓	✓	✓	✓	✓	✓	✓	✓	✓	✓

The BUS voltage is the DC voltage on the bus capacitors. The driver is continuously monitoring this voltage and will stop the motor in the event of under-voltage or over-voltage.

The value can be monitored through the [Input Register 9](#).

Motor Voltage

The motor voltage is the peak value of the phase voltage module.

To know the rms line to line value, it has to be multiplied by $\sqrt{3}/2$.

The value can be monitored through the [Input Register 13](#).

Availability									
DDMP			RDP			PFP		FDP	
1-Phase		3-Phase	1-Phase		3-Phase	1-Phase	3-Phase	1-Phase	
1.05kW	2.1kW	2.65kW	1.05kW	2.1kW	2.65kW	1.35kW	2.65kW	1.05kW	
✓	✓	✓	✓	✓	✓	✓	✓	✓	✓

Enable Function

Availability								
DDMP			RDP			PFP		FDP
1-Phase		3-Phase	1-Phase		3-Phase	1-Phase	3-Phase	1-Phase
1.05kW	2.1kW	2.65kW	1.05kW	2.1kW	2.65kW	1.35kW	2.65kW	1.05kW

A safety enable function is available and it is active for the Operating Modes in Table 16.

The value can be monitored through the [Input Register 28](#).

Input Type	Enable Function
0	Not Active
1	Active
2	Active
3	Active
4	Active
5	Not Active
6	Active
7	Active
8	Not Active
9	Active
10	Active
11	Not Active
12	Active

Table 16

Derating and Overheating protections

Driver overheating: DERATING

Feature Availability								
DDMP			RDP			PFP		FDP
1-Phase		3-Phase	1-Phase		3-Phase	1-Phase	3-Phase	1-Phase
1.05kW	2.1kW	2.65kW	1.05kW	2.1kW	2.65kW	1.35kW	2.65kW	1.05kW

When the temperature of the driver components overtakes a fixed threshold of 75°C, the performance is automatically reduced in order to decrease the heating. It is possible to check in real time the temperature by reading the [Input Register 15](#).

If it is not possible to reach a steady thermal equilibrium, the driver shuts down. The protection acts limiting the current to the motor. In this condition the driver goes in alarm (see the Alarm Handling chapter)

Once the temperature on the driver decreases under 75°C the alarm is automatically reset.

Motor overheating: THERMAL PROTECTOR

Feature Availability								
DDMP			RDP			PFP		FDP
1-Phase		3-Phase	1-Phase		3-Phase	1-Phase	3-Phase	1-Phase
1.05kW	2.1kW	2.65kW	1.05kW	2.1kW	2.65kW	1.35kW	2.65kW	1.05kW

The motor is protected through one or more Thermal Protector.

If the motor temperature is too high the thermal protector opens one phase and the driver recognizes the error and it stops the fan (see the Alarm Handling chapter).

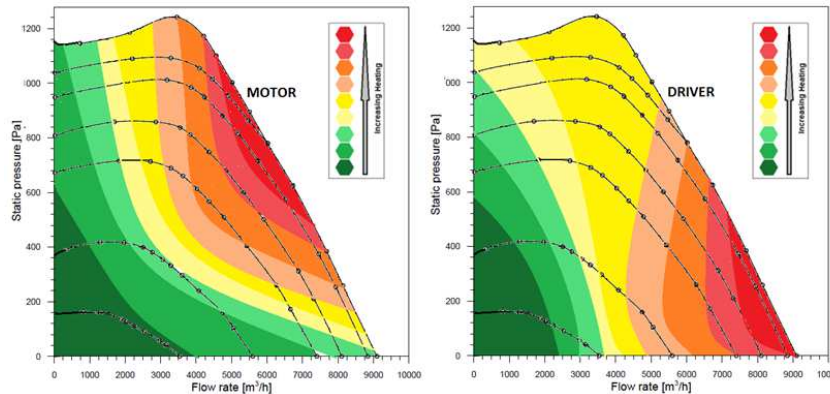
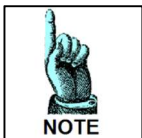

Fig. 11 – Example of a RDP motor and driver overheating



The Motor Winding temperature and the driver derating are dependent on the fan size and on the fan working point.

Therefore it is possible that the fan could work at 50°C without a performance limitation



The Driver and motor areas are rated for operating in a temperature range between -20°C and +40°C. The derating is tested and guaranteed from +40°C to +50°C.

Higher temperatures could damage the motor winding or the performance could be strongly reduced.

Master&Slave Mode

The Master&Slave connection is necessary when two fans in parallel can influence each other, this occurs for example in Constant Airflow mode.



Fig. 12 – MASTER/SLAVE connection 0-10V

Master and Slave 0-5V PWM out

Feature Availability									
DDMP			RDP			PFP		FDP	
1-Phase		3-Phase	1-Phase		3-Phase	1-Phase	3-Phase	1-Phase	
1.05kW	2.1kW	2.65kW	1.05kW	2.1kW	2.65kW	1.35kW	2.65kW	1.05kW	
✓	✓	✗	✓	✓	✗	✗	✗	✓	

The driver has a digital output ranging from 0 to 5V and a special configuration is necessary for a Master&Slave connection. It is possible to drive two fans in a master and slave configuration by setting the MASTER in one preferred mode and the SLAVE in Master&Slave mode only.

The SLAVE operating mode must be changed (**INPUT TYPE = 3**).

The MASTER must have the Holding Register 46 set at 0 = TACHO.

Master and Slave 0-10V PWM out

Feature Availability								
DDMP			RDP			PFP		FDP
1-Phase		3-Phase	1-Phase		3-Phase	1-Phase	3-Phase	1-Phase
1.05kW	2.1kW	2.65kW	1.05kW	2.1kW	2.65kW	1.35kW	2.65kW	1.05kW

In this case through the digital output it is possible to drive two fans in a master and slave configuration. The master can have any possible configuration, while the slave must be configured in Analog Speed Control. The MASTER must have the Holding Register 46 set at 0 = TACHO.

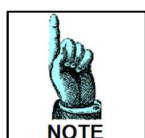

In this mode if the slave is set in Master&Slave mode, it runs at double speed of the master.

COMMUNICATION

Protocol interface:

MODBUS RTU (RS485 or Bluetooth)

Baud rate

The baud rate can be set through the Holding Register 47 and the possible speeds are:

RS-485 CABLE: 9.6kbps and 19.2kbps (higher speeds are not allowed due to the board Opto-Insulators)

RS-232 OFFLINE CABLE: 9.6kbps, 19.2kbps, 38.4kbps and 57.6kbps.

Parity and Stop bits

The parity and the stop bits can be chosen by modifying the Holding Register 48 and the possible choices are:

0	No parity, 2 Stop Bits (default)
1	Odd parity, 1 Stop Bit
2	Even parity, 1 Stop Bit

Supported Function:

03	Read Holding Registers
04	Read Input Registers
06	Write Single Holding Register

Modbus Communication Timeout

With this feature it is possible to stop the fan when the communication is lost, after a period of time set in the Holding Register 56 . The register can be set to:

0	No Communication Timeout
1 to 32767	time expressed in seconds, therefore it is possible to set from 1sec to 9h 6m 8 sec

When the timeout occurs the driver goes in alarm condition and the communication must be restored and the alarm must be cleared. The alarm is indicated in the Input register 17 with the value of 255 (0xFF).

Modbus Address

The slave device address can be changed from value 1 to 247 by modifying the Holding Register 45 .

The default address from factory configuration is 1.

Broadcast Address

The Broadcast address is 0.

RS-485 Default Communication Parameters

RS-485 Default communication									
	DDMP			RDP			PFP		FDP
	1-Phase		3-Phase	1-Phase		3-Phase	1-Phase	3-Phase	1-Phase
	1.05kW	2.1kW	2.65kW	1.05kW	2.1kW	2.65kW	1.35kW	2.65kW	1.05kW
Baud rate	9600	9600	9600	9600	9600	9600	9600	9600	9600
Parity and Stop Bits	0	0	0	0	0	0	0	0	0
Modbus Address	1	1	1	1	1	1	1	1	1

Table 17

RS-232 (OFFLINE) Default Communication Parameters

RS-232 OFFLINE Default communication									
	DDMP			RDP			PFP		FDP
	1-Phase		3-Phase	1-Phase		3-Phase	1-Phase	3-Phase	1-Phase
	1.05kW	2.1kW	2.65kW	1.05kW	2.1kW	2.65kW	1.35kW	2.65kW	1.05kW
Baud rate	9600	9600	57600	9600	9600	57600	57600	57600	9600
Parity and Stop Bits	0	0	0	0	0	0	0	0	0
Modbus Address	1	1	1	1	1	1	1	1	1

Table 18

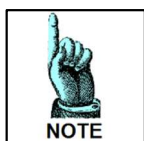

The value of the Holding Registers is NOT coerced if trying to set a not allowed value.

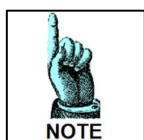

Changing the Baud rate has an immediate effect, while the other communication parameters require the complete fan power off and consequently power on (wait until the complete discharge of the capacitors and the led turning off, otherwise the changes are not written into the EEPROM)

Temporary Holding Register

The Holding Register 66 is a special register used in each operating mode for setting the speed, the airflow, the slip and the PID reference.

It is not a physical register and it can be written, but it is not possible to read its value.

The setting remains active meanwhile the fan is powered on.

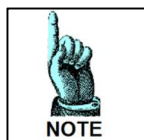

If the fan is powered off but there is a residual charge, the microcontroller of the driver is still functioning. Therefore if it is powered on in this situation the value set through the register 66 is still active.

Fixed Holding Register

The drivers Holding Registers permanently stored into the EEPROM are 64, but only 26 registers are modifiable by the end user (see Table 19).

The most important **Holding Register 34** is the **Input Type** related to the selection of the Operating Mode.

0	Reset	43	Max Airflow
1	Min Speed	45	Modbus Address
2	Max Speed	46	Tacho\Alarm\Filter
7	Max Current	47	Modbus Baud rate
21	Fixed Speed Setting	48	Modbus Parity and Stop Bits
30	Asynchronous Slip Setting	49	Max Input Current
31	PID positive/negative	50	External PID Setting
32	Avoid Range Start	51	PID Kp
33	Avoid Range End	52	PID Ki
34	Input Type	53	PID Kd
36	Max Power Out	54	PID Time
39	Constant Airflow Setting	55	Speed Threshold
42	Min Airflow	56	Communication Timeout

Table 19

Holding Registers Description



The Holding Register must be set with the fan stop.
Changing the parameters during functioning may cause unexpected behavior.



Don't set the values outside the indicated limits, the driver could stop working without any alarm indication, it could be reset or could work in an undefined condition.

Holding Register 0: RESET [Adim]

This register can be used to reset the fan by writing the value 1 on it. This register automatically return to value 0 after the reset. The driver will reset any error condition and it will try to restart.

Allowed values = 0 and 1	Default value = 0
--------------------------	-------------------

Holding Register 1: Min Speed [RPM]

This register is used to set the minimum speed of the fan.

Allowed values = [Default Value, Max Speed]	Default Value = Table 20
---------------------------------------------	--------------------------

		DDMP											
Table 20 - A		7/7T	7/7	7/9	8/7T	9/7	8/9T	225/240	9/9	10/8	10/10	12/9	12/12
1.05kW	1-Phase	400	400	400	400	400	400	400	400	400	400	---	---
2.1kW	1-Phase	---	---	---	---	---	---	---	300	300	300	300	300
2.65kW	3-Phase	---	---	---	---	---	---	---	---	---	---	---	---

		RDP			
Table 20 - B		280	315	355	400
1.05kW	1-Phase	500	500	400	---
2.1kW	1-Phase	800	500	500	200
2.65kW	3-Phase	300	300	150	150

		PFP					
Table 20 - C		280	315	355	400	450	500
1.35kW	1-Phase	500	400	400	300	300	300
2.65kW	3-Phase	300	300	150	150	150	---

		FDP					
Table 20 - D		200/190 1413H3	200/240 1413H3	9/7 1413H3	9/9 1413H3	200/190 1413G6	180/240 1413G6
1.05kW	1-Phase	400	400	400	400	400	400

Holding Register 2: Max Speed [RPM]

This register can be used to set the max speed of the fan.

Allowed values = [Min Speed, Default Value]	Default Value = Table 21
----------------------------------------------------	---------------------------------

DDMP													
Table 21 - A		7/7T	7/7	7/9	8/7T	9/7	8/9T	225/240	9/9	10/8	10/10	12/9	12/12
1.05kW	1-Phase	3000	2000	2000	2000	2000	2000	2000	2000	2000	2000	---	---
2.1kW	1-Phase	---	---	---	---	---	---	---	2000	2000	2000	1600	1600
2.65kW	3-Phase	---	---	---	---	---	---	---	---	---	---	---	---

RDP					
Table 21 - B		280	315	355	400
1.05kW	1-Phase	2600	2200	1800	---
2.1kW	1-Phase	3200	2770	2080	1700
2.65kW	3-Phase	3700	3100	2500	2000

PFP							
Table 21 - C		280	315	355	400	450	500
1.35kW	1-Phase	3350	2890	2500	2000	1680	1425
2.65kW	3-Phase	3350	2890	2680	2480	1950	---

FDP							
Table 21 - D		200/190 1413H3	200/240 1413H3	9/7 1413H3	9/9 1413H3	200/190 1413G6	180/240 1413G6
1.05kW	1-Phase	1550	1550	1550	1550	1550	1550

Holding Register 7: Max Current [mA]

This register can be used to reduce the max motor current.

Allowed values = [Default value, Max Speed]	Default Value = Table 22
----------------------------------------------------	---------------------------------

DDMP													
Table 22 - A		7/7T	7/7	7/9	8/7T	9/7	8/9T	225/240	9/9	10/8	10/10	12/9	12/12
1.05kW	1-Phase	6000	4500	4500	4500	4500	4500	4500	4500	5500	5500	---	---
2.1kW	1-Phase	---	---	---	---	---	---	---	8300	8300	8300	8300	8300
2.65kW	3-Phase	---	---	---	---	---	---	---	---	---	---	---	---

RDP					
Table 22 - B		280	315	355	400
1.05kW	1-Phase	5000	6000	5000	---
2.1kW	1-Phase	7220	6700	7600	7000
2.65kW	3-Phase	8000	8000	8000	7200

PFP							
Table 22 - C		280	315	355	400	450	500
1.35kW	1-Phase	6000	6500	6500	6500	6500	6500
2.65kW	3-Phase	4200	5700	6700	8000	6700	---

FDP							
Table 22 - D		200/190 1413H3	200/240 1413H3	9/7 1413H3	9/9 1413H3	200/190 1413G6	180/240 1413G6
1.05kW	1-Phase	3850	3850	3850	3850	2450	2450

Holding Register 21: Fixed Speed setting [RPM]

This register can be used to set the speed in *Fixed Speed Control Mode*

The register is active when the Input Type Holding Register 34 is set to the value 2.

Allowed values = [Min Speed, Max Speed]	Default Value = 0
------------------------------------------------	--------------------------

Holding Register 30: Asynchronous Slip. [%]

This register can be used to set the slip of an emulated ACIM motor.

The register is active when the Input Type Holding Register is set to the value 9.

Allowed values = [0, 100]	Default Value = 0
----------------------------------	--------------------------

Holding Register 31: PID Positive/Negative [Adim]

This register can be used to invert the feedback behavior of the PID.

Allowed values = 0 and 1	Default Value = 0
---------------------------------	--------------------------

Holding Register 32: Avoid Range Start [RPM]

This register combined with the Avoid Range End can be used to skip some resonance frequencies of the fan.

Allowed values = [0, Avoid Range End]	Default Value = 20000
----------------------------------------------	------------------------------

Holding Register 33: Avoid Range End [RPM]

This register combined with the Avoid Range Start can be used to skip some resonance frequencies of the fan.

Allowed values = [Avoid Range Start, 20000]	Default Value = 20000
----------------------------------------------------	------------------------------

Holding Register 34: Input Type [Adim]

This register defines all the possible operating modes:

Allowed values = [0,12]		Default Value = 1
0	Modbus Speed Control	The speed is set by modifying the register 66
1	Analog Speed Control	The speed is set through the analog signal
2	Modbus Fixed Speed Control	The speed is set by modifying the register 21
3	Master&Slave	The fan is configured as slave and follows the master.
4	Analog Constant Airflow	The constant airflow is set through the analog signal
5	Modbus Temporary Constant Airflow	The constant airflow is set by modifying the register 66
6	Modbus Fixed Constant Airflow	The constant airflow is set by modifying the reg. 39
7	Analog Asynchronous Emulation	The emulation is set through the analog signal
8	Modbus Temporary Asynchronous Emulation	The emulation is set by modifying the register 66
9	Modbus Fixed Asynchronous Emulation	The emulation is set by modifying the register 30
10	Analog Ref. PID Closed Control Loop	The PID ref. is set through the analog signal
11	Modbus Temporary Ref. PID Closed Control Loop	The PID ref. is set by modifying the register 66
12	Modbus Fixed Ref. PID Closed Control Loop	The PID ref. is set by modifying the register 50

Table 23

Holding Register 36: Maximum Power [W]

This register can be set to reduce the power out to the motor.

Allowed values = [10, Default Value]	Default Value = Table 24
---------------------------------------------	---------------------------------

Table 24		EC Fans	Value
1.35kW	1-Phase	PPF	1350
2.65kW	3-Phase	PPF-DDMP-RDP	2650
1.05kW	1-Phase	DDMP-RDP-FDP	1050
2.1kW	1-Phase	DDMP-RDP	2100

Holding Register 39: Constant Airflow [m3/h]

This register can be used to set the constant airflow value.

The register is active when the Input Type Holding Register is set to the value 6.

Allowed values = [Min Airflow, Max Airflow]	Default Value = 0
----------------------------------------------------	--------------------------

Holding Register 42: Min Airflow [m3/h]

This register can be used to set the min constant airflow.

Allowed values = [Default Value, Max Airflow]	Default Value =Table 25
------------------------------------------------------	--------------------------------

		DDMP											
Table 25		7/7T	7/7	7/9	8/7T	9/7	8/9T	225/240	9/9	10/8	10/10	12/9	12/12
1.05kW	1-Phase	1000	500	1000	750	1000	1000	1000	1000	1000	1000	---	---
2.1kW	1-Phase	---	---	---	---	---	---	---	1000	1000	1000	1500	1500
2.65kW	3-Phase	---	---	---	---	---	---	---	---	---	---	---	---

Holding Register 43: Max Airflow [m3/h]

This register can be used to set the min constant airflow.

Allowed values = [Min Airflow, Default Value]	Default Value =Table 26
------------------------------------------------------	--------------------------------

		DDMP											
Table 26		7/7T	7/7	7/9	8/7T	9/7	8/9T	225/240	9/9	10/8	10/10	12/9	12/12
1.05kW	1-Phase	1950	3000	3500	2750	3000	3250	3250	3250	3750	4000	---	---
2.1kW	1-Phase	---	---	---	---	---	---	---	5000	4500	5000	4500	5000
2.65kW	3-Phase	---	---	---	---	---	---	---	---	---	---	---	---

Holding Register 45: Modbus Address [Adim]

This register can be used to change the Modbus address of a driver.

Allowed values = [1, 247]	Default Value =1
---------------------------	------------------

Holding Register 46: Tachometric/ Alarm/Threshold [Adim]

This register can be used to set the digital output function.

Allowed values = [Table 27]	Default Value =0
-----------------------------	------------------

The possible settings are:

Table 27		
0	Tachometric	The digital output indicates the measured speed through a PWM signal.
1	Alarm	The digital output indicates when an alarm occur.
2	Threshold	The digital output indicates when the speed set in the Holding Register 55 is overtaken

Table 27

Holding Register 47: Modbus Speed [10^{-1} kbps]

This register can be used to set the Modbus speed.

Allowed values = [Table 28]	Default Value =96
-----------------------------	-------------------

Range:

Table 28	
96	corresponding to 9.6kbps
192	corresponding to 19.2kbps
384	corresponding to 38.4kbps (not available using the opto-insulated terminal block)
576	corresponding to 57.6kbps (not available using the opto-insulated terminal block)

Table 28

Holding Register 48: Modbus Stop Bits [Adim] (Default = 0)

This register can be used to set the parity and the stop bits.

Allowed values = [Table 29]	Default Value =0
-----------------------------	------------------

Range:

Table 29	
0	2 Stop Bits/No Parity
1	1 Stop Bit/Even Parity
2	1 Stop Bit/Odd Parity

Table 29

Holding Register 50: External Set [10^{-1} V]

This register can be used to set the reference of the PID control.

Allowed values = [0, 100]	Default Value =0
---------------------------	------------------

The register is active when the Input Type Holding Register is set to the value 12.

Holding Register 51: Kp [Adim]

This register can be used to set the Proportional Gain of the PID control.

Allowed values = [0, 32767]	Default Value =0
-----------------------------	------------------

Holding Register 52: Ki [Adim]

This register can be used to set the Integral Gain of the PID control.

Allowed values = [0, 32767]	Default Value =0
-----------------------------	------------------

Holding Register 53: Kd [Adim]

This register can be used to set the Derivative Gain of the PID control.

Allowed values = [0, 32767]	Default Value =0
-----------------------------	------------------

Holding Register 54: Period [ms]

This register can be used to set the time constant of the PID control.

Allowed values = [0, 32767]	Default Value =0
-----------------------------	------------------

Holding Register 55: Speed Threshold [RPM]

This register can be used to set the speed threshold, when the measured speed in the Input Register 3 overtakes the threshold value.

Allowed values = [0, Max Speed]	Default Value =0
---------------------------------	------------------

Speed Threshold =0 means that it is **DEACTIVATED**

Holding Register 56: Communication Timeout [s]

This register can be used to set a timeout period for the communication.

Allowed values = [0, 9hour 8min 8sec]	Default Value =0
---------------------------------------	------------------

At the end of the period set into the register the fan stops and there is an Alarm indication.

To restart a reset command must be sent. Communication Timeout =0 means that it is **DEACTIVATED**

Input Register Description

The Modbus Input Registers are in total 33, but only 14 are useful for the end user.

2	Speed Reference	[rpm]	15	Module Temperature	[10 ⁻¹ °C]
3	Measured Speed	[rpm]	17	Alarm 2	[Adim]
9	Bus Voltage	[10 ⁻¹ V]	28	Enable Input	[$\frac{10}{2^{16}}$ V]
10	Alarm 1	[Adim]	29	Analog Input	[$\frac{10}{2^{16}}$ V]
12	Motor Current	[mA]	30	Transducer Input	[$\frac{10}{2^{16}}$ V]
13	Motor Voltage	[10 ⁻¹ V]	31	Measured Power	[W]
14	Analog Input	[10 ⁻¹ V]	32	Input Current	[mA]

Table 30

Input Register 2: Speed Reference [rpm]

This register indicates the speed reference during the functioning. During the starting phase it is equal to the Min Speed and then gradually increases to the target speed depending on the selected mode.

Input Register 3: Measured Speed [rpm]

This register indicates the speed during the functioning.

Input Register 9: Bus Voltage [10⁻¹ V]

This register indicates the rectified voltage after the PFC stage.

Input Register 10: Alarm 1 [Adim]

This register must be combined with the Alarm2 register (see the alarm lookup table)

Input Register 12: Motor Current [mA]

This register indicates the peak value of the line current module.

To know the rms value, it has to be divided by $\sqrt{2}$.

Input Register 13: Motor Voltage [10⁻¹ V]

This register indicates the peak value of the phase voltage module. To know the rms line to line value, it has to be multiplied by $\sqrt{3}/2$.

Input Register 14: Analog Input [10⁻¹ V]

This register indicates the analog voltage value present at the input.

Input Register 15: Module Temperature [10⁻¹ °C]

This register indicates the temperature of the power module of the driver. When the value exceeds 75°C the driver enters in a derating process where the performances are automatically decreased until a thermal equilibrium below 75°C is reached.

If this equilibrium is not reached, the fan stops and an alarm condition is activated. As soon as the heating decreases and the power module temperature is below 75°C, the alarm is automatically reset.

Input Register 17: Alarm 2 [Adim]

This register must be combined with the Alarm1 register

Input Register 28: Enable Input [Adim]

This input indicates the ENABLE state.

The value must be multiplied by $\frac{10V}{2^{16}}$ to have the corresponding voltage value

Input Register 29: Analog Input [Adim]

This input indicates the Reference Value.

The value must be multiplied by $\frac{10V}{2^{16}}$ to have the corresponding voltage value

Input Register 30: Transducer Input [Adim]

This input indicates the Transducer Value.

The value must be multiplied by $\frac{10V}{2^{16}}$ to have the corresponding voltage value

Input Register 31: Measured Power [W]

This register indicates the absorbed power.

Input Register 32: Input Current [mA]

This input indicates the input absorbed current .

Fan info and Modbus Registers

There are three Modbus registers showing information about the fan (see Table 31 and 32).

The **Holding Register 44** indicating the fan model, the **Input Register 0** indicating the driver firmware version and the **Input Register 1** indicating the driver model.

		DDMP											
Table 31 - A		7/7T	7/7	7/9	8/7T	9/7	8/9T	225/240	9/9	10/8	10/10	12/9	12/12
1.05kW	1-Phase	1	2	3	4	5	6	7	8	9	10	---	---
2.1kW	1-Phase	---	---	---	---	---	---	---	1	2	3	4	5
2.65kW	3-Phase	---	---	---	---	---	---	---	---	---	---	---	---

		RDP			
Table 31 - B		280	315	355	400
1.05kW	1-Phase	1	2	3	4
2.1kW	1-Phase	1	2	3	4
2.65kW	3-Phase	1	2	3	4

		PFP					
Table 31 - C		280	315	355	400	450	500
1.35kW	1-Phase	1	2	3	4	5	6
2.65kW	3-Phase	1	2	3	4	5	---

		FDP					
Table 31 - D		200/190 1413H3	200/240 1413H3	9/7 1413H3	9/9 1413H3	200/190 1413G6	180/240 1413G6
1.05kW	1-Phase	1	2	3	4	5	6

Table 32	DDMP			RDP			PFP		FDP
	1-Phase		3-Phase	1-Phase		3-Phase	1-Phase	3-Phase	1-Phase
	1.05kW	2.1kW	2.65kW	1.05kW	2.1kW	2.65kW	1.35kW	2.65kW	1.05kW
Firmware Version	5	5	6	6	6	6	6	6	6
Frequency Converter Model	41504	45600	45091	41505	45601	45091	49696	40995	41505
Frequency Converter Code	1431A5 1431F1	1431A8	1431F0	1431C1	1431E7	1431F0	1431F2	1431F3	1431C1

ALARM HANDLING

When a malfunctioning occurs the driver has two possible behaviors depending on the cause of the alarm:

BLOCKING	The cause of the alarm is very dangerous → The driver stops immediately. To restart the fan, once the problem is corrected, it is necessary to reset the fan or power the driver off for 5 minutes.
AUTO-RESTARTING	The cause of the alarm is contingent to a wrong setting or wrong working condition. The alarm indications are activated, but after some seconds the fan tries to restart automatically.

Monitoring:

The alarms can be monitored through three different ways:

Modbus Registers
Blinking LED
Digital Output

Modbus Registers - Alarm description:

In Table 28 the alarms and the values stored in the related Modbus [Input Register 10](#) and [Input Register 17](#) are indicated.

Alarm1	Alarm2	Description	Actions	Type
0	0	Default operation – No Errors	No Actions	ALARM 1
1	0	Memory error	Blocking condition	ALARM 2
2	0	Short Circuit	Blocking condition	ALARM 3
3	0	Loss of synchronism	Auto-restarting condition	ALARM 4
4	1	Input Voltage outside range (only with motor stopped)	Auto-restarting condition	ALARM 4
4	32	BUS overvoltage (instantaneous measurement)	Auto-restarting condition	ALARM 4
4	33	BUS undervoltage (instantaneous measurement)	Auto-restarting condition	ALARM 4
4	34	Input relay not closed	Auto-restarting condition	ALARM 4
4	49	Missing phase – U cable disconnected	Blocking condition	ALARM 4
4	50	Missing phase – V cable disconnected	Blocking condition	ALARM 4
4	51	Missing phase – W cable disconnected	Blocking condition	ALARM 4
4	52	High starting current	Auto-restarting condition	ALARM 4
4	113	Overtemperature	Auto-restarting condition	ALARM 4
4	255	Loss of communication	Blocking condition	ALARM 4

Table 33



**The Driver is NOT protected against a very high power supply voltage.
A very low power supply voltage during the motor running could damage Driver**

Blinking Led - Alarm description:

In figure 13 the blinking LED is shown (i.e. board of the 1kW driver).

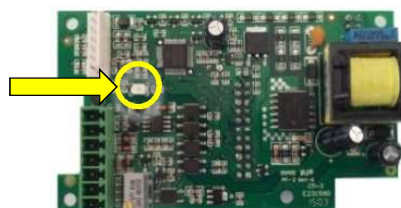
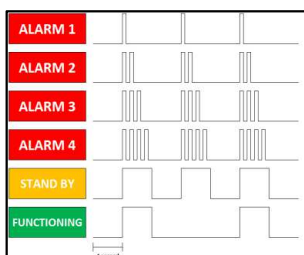

Fig. 13 – Blinking LED

Digital Output

The driver output can be configured as Alarm output by modifying the **Holding Register 46** to value 1. During the normal functioning the value is 0V and when an alarm occurs the output value is 5V see fig. 14.

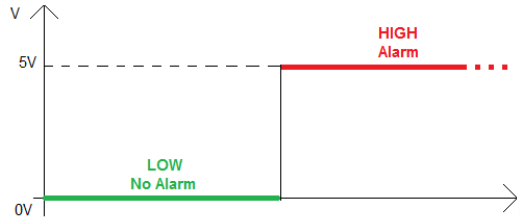

Figure 14 – Output behavior

Alarm Reset

The alarms are automatically reset following the action of the Table 34:

Operating Mode	Input Type	Action
Analog	1, 4, 7, 10	Signal set to 0V
Fixed	2, 6, 9, 12	Registers 21, 39, 30 and 50 set to 0

For the Temporary Modbus Mode it is necessary to reset the fan by setting the Holding Register 0 to value=1 instead of setting to 0 the Register 66

Temporary	0, 5, 8, 11	Register 0 set to 1
-----------	-------------	---------------------

Table 34

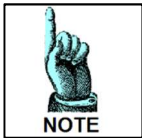

The Holding Register 0 is a general reset and works also in the Analog mode and Fixed mode

AVAILABLE SOFTWARE

A freeware software is available on Nicotra|Gebhardt site (<http://www.nicotra-gebhardt.com>) for monitoring the fans. Please refer to the related manual for more details.

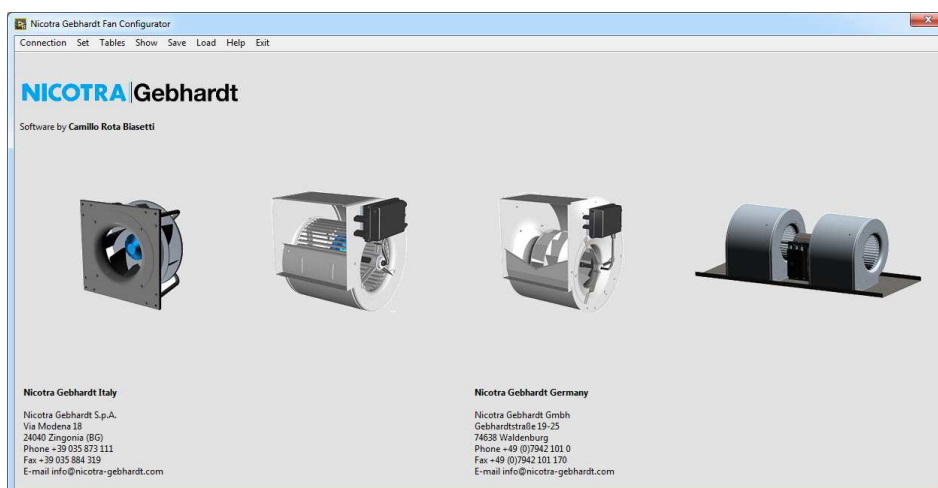

Fig. 15 – Available software



The software can be used for configuring the fan and monitoring the performance. The performance is estimated through an algorithm and therefore subjected to variable tolerance depending on the working point, airflow stability and the constant algorithm resolution itself.

ANNEX

Analog Signal Considerations

Voltage and Speed

This paragraph shows the way to find the voltage V_{IN} required to achieve the $Speed_{Desired}$ using the diagram Signal/Speed of figure 16

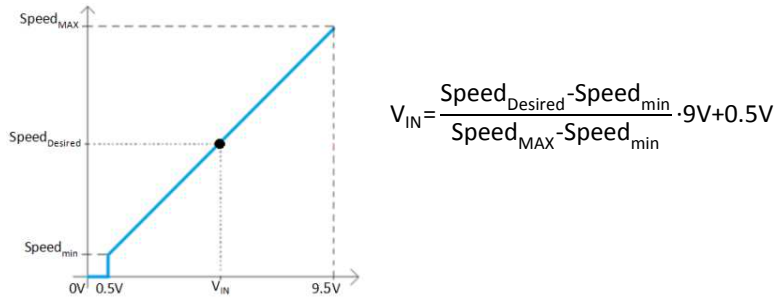
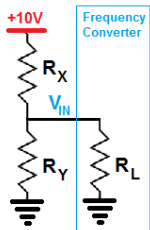
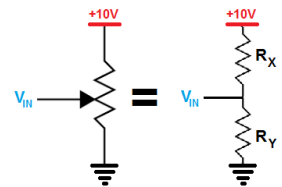

Fig. 16 – Speed/Signal relationship

Potentiometer setting

$R_{Pot} = R_x + R_y$ is the potentiometer resistance.

The input resistance of the driver is R_L and the voltage power supply $V_+ = 10V$



Connecting the potentiometer to the driver analog input the voltage value is

$$V_{IN} = \frac{V_+}{R_x + \frac{R_y R_L}{R_y + R_L}} \cdot \frac{R_y R_L}{R_y + R_L} = \frac{V_+ R_y R_L}{R_x R_y + R_x R_L + R_y R_L} = \frac{V_+ R_y R_L}{(R_{pot} - R_y) R_y + R_{pot} R_L} = \frac{V_+ R_y R_L}{R_{pot} R_L + R_{pot} R_y - R_y^2}$$

$\frac{R_y}{R_{pot}} = \alpha$ represent the position of a linear potentiometer and the previous formula $\alpha^2 V_{IN} R_{pot} + (10R_L - V_{IN} R_{pot})\alpha - V_{IN} R_L = 0$

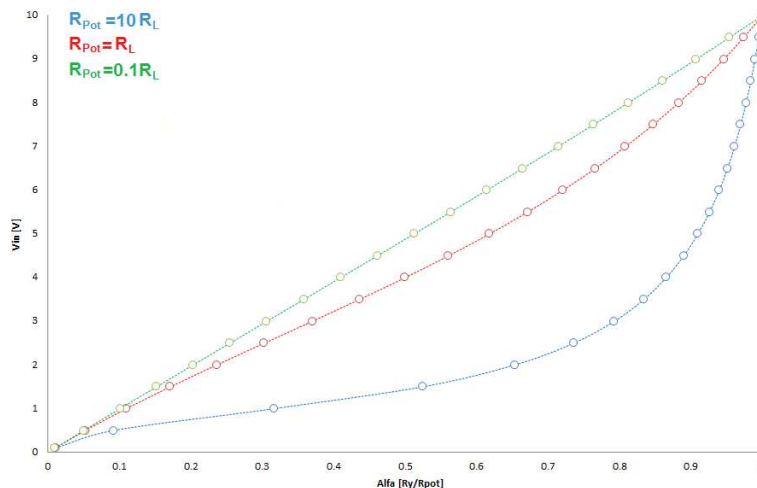

Fig.17 – Voltage signal in function of the position of the potentiometer

$R_{pot} = 10R_L$	$V_{IN} 10\alpha^2 + (10 - V_{IN} 10)\alpha - V_{IN} = 0$
$R_{pot} = R_L$	$V_{IN} \alpha^2 + (10 - V_{IN})\alpha - V_{IN} = 0$
$R_{pot} = 0.1R_L$	$V_{IN} \alpha^2 + (100 - V_{IN})\alpha - 10V_{IN} = 0$

Observing the case $R_{pot} = 10R_L$ at 90% of the potentiometer position the analog voltage value is still below 5V and therefore a very high sensibility to regulate the analog voltage value in the remaining 10% is required.

This consideration must be done especially when N fans are connected in parallel where $R_{Lparallel} = \frac{R_L}{N}$. Therefore the choice of the potentiometer value is very important basing on the input resistance of the driver used.

Unfortunately another limitation when choosing the potentiometer value comes from the max current supplied by the +10V power supply of the drivers.

In this case the max available current is 5mA, above this value there is a significant voltage drop, therefore the minimum potentiometer value can be $R_{Pot} = 2k\Omega$

Sensorless Constant Pressure

In this paragraph there is an approximate explanation about why the Sensorless Constant Pressure is not applicable unless several compromises are accepted.

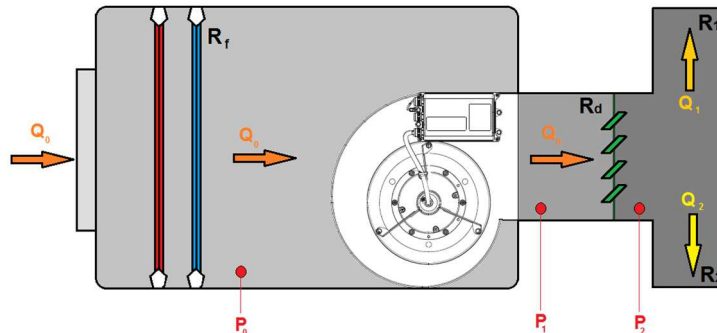

Fig. 18 – Final fan installation

All the airflow systems are assumed to be coherent with the approximate formula $P = kQ^2$

For this analysis we consider a simple analogy with electrical components:

Let's assume that the sum of the Airflows in a node of the system is equal to 0 and that the sum of the Pressures in a closed network is equal to 0.

$$\sum_{i=0}^n Q_i = 0 \quad \text{and} \quad \sum_{j=0}^n P_j = 0$$

Here the used symbols:

Loads (channels)	variable loads (filters)	Constant Pressure Generator	Constant Airflow Generator	Static Pressure = 0

Fig. 19 - Symbols

Considering the model of figure 18 the corresponding schematic when the fan is working in constant airflow mode is shown in figure 20.

The fan is able to keep the airflow constant $Q_{const} = Q_0$ along the net independently from loads conditions

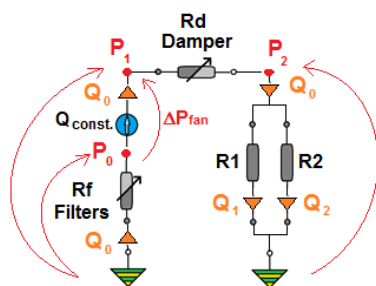

Fig. 20 – Schematic of fig. 18

Using the law at the nodes:

$$Q_0 = Q_1 + Q_2 = \sqrt{\frac{P_2}{R_1}} + \sqrt{\frac{P_2}{R_2}}$$

The R_1 and R_2 are not variable loads so also Q_1 and Q_2 are constant. Proceeding with the square of the equation:

$$Q_0^2 = \frac{P_2}{R_1} + \frac{P_2}{R_2} + 2P_2 \sqrt{\frac{1}{R_1 R_2}} = P_2 \left(\frac{1}{R_1} + \frac{1}{R_2} + 2\sqrt{\frac{1}{R_1 R_2}} \right)$$

$$P_2 = \frac{1}{\left(\frac{1}{R_1} + \frac{1}{R_2} + 2\sqrt{\frac{1}{R_1 R_2}}\right)} Q_0^2 \quad \text{defining} \quad R_{eq-1} = \frac{R_1 \cdot R_2}{R_1 + R_2 + 2\sqrt{R_1 R_2}} \quad \text{then} \quad P_2 = R_{eq-1} Q_0^2 \quad R_{eq-PARALLEL} = \frac{1}{\left(\sum_{i=0}^n \frac{1}{\sqrt{R_i}}\right)^2}$$

Using the law at the networks

$$P_1 = P_2 + R_d \cdot Q_0^2 = R_{eq-1} Q_0^2 + R_d \cdot Q_0^2 = (R_{eq-1} + R_d) \cdot Q_0^2 \quad \text{defining} \quad R_{eq-2} = R_{eq-1} + R_d \quad \text{then} \quad P_1 = R_{eq-2} \cdot Q_0^2$$

Assuming:

$$R_{eq-SERIES} = \sum_{i=0}^n R_i \quad \Delta P_{Fan} = P_1 - P_0 = R_{eq-2} \cdot Q_0^2 + R_f Q_0^2 = R_{eq-3} Q_0^2 \quad \text{Where} \quad R_{eq-3} = R_{eq-2} + R_f$$

The fan works keeping $Q_0 = const$ and changing its ΔP_{Fan}

Considering now the same model but with the fan working in constant pressure mode shown in figure 21

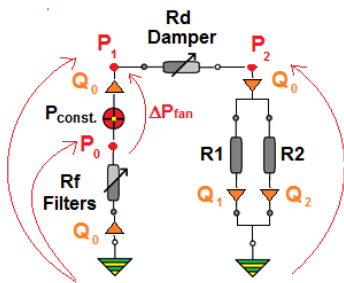

Fig. 21 – Constant Pressure

The fan can be programmed in the lab to keep the $\Delta P_{fan} = const$

Generally the fan in Nicotra | Gebhardt laboratory is tested free inlet ducted outlet, but without knowing the final application for the constant pressure it should be tested at free inlet and free outlet.

Considerations:

The pressure in all the points of the installation must be calculated from the ΔP_{Fan} knowing all the loads values of the final installation.

$$P_1 = (R_d + R_{eq-1}) \cdot Q_0^2 \quad \text{so} \quad R_d \quad \text{changes and therefore} \quad P_1 \quad \text{can't be kept constant}$$

A solution should be to create a customized sensorless constant pressure unit $\Delta P_{unit} = const$ (see fig. 22)

(This would also imply that each customer should have to send each unit model to Nicotra | Gebhardt laboratory for measurements)

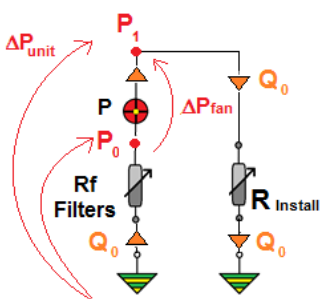

Fig. 22 - Customized constant pressure

At time $t = t_0$ all data of customers' units are acquired when the value of R_f is

$$R_{f_0} \quad \text{therefore} \quad \Delta P_{unit} = P_1 = \Delta P_{fan} + P_0 = \Delta P_{fan} - Q_0^2 R_{f_0} \quad \text{with} \quad Q_0^2 = \frac{\Delta P_{unit}}{R_{install}}$$

For a specific load condition $R_{install} = R_x$ the fan algorithm works on the value

$$\frac{\Delta P_{fan_x}}{Q_{0_x}^2} = R_x + R_{f_0}$$

At time $t = t_1$ the status of the filters are changed into R_{f_1} and in the same load condition R_x , the fan is not able to discriminate this change so $P_{1_{x_0}} - P_{1_{x_1}} = \Delta P_{fan_x} - Q_{0_x}^2 R_{f_0} - \Delta P_{fan_x} + Q_{0_x}^2 R_{f_1} = Q_{0_x}^2 (R_{f_1} - R_{f_0})$

This means that the pressure P_1 gradually decreases depending on the status of the filters

Conclusion:

The sensorless constant pressure can't be guaranteed and therefore not implemented into the Nicotra | Gebhardt products.

Sensorless Constant Airflow

The fan working in Constant Airflow mode is ideally a generator able to maintain the same airflow independently from the applied load (Fig. 23).

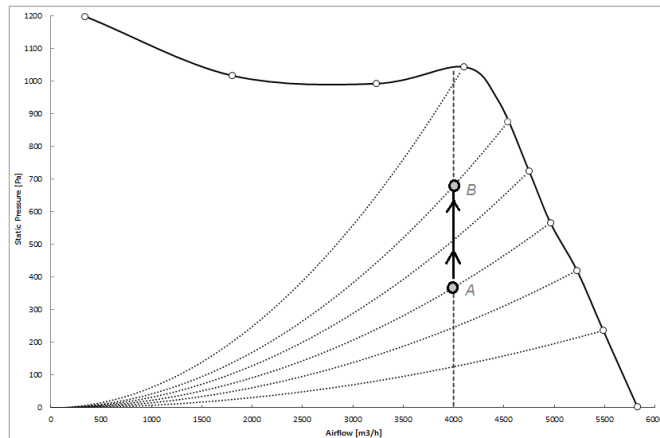
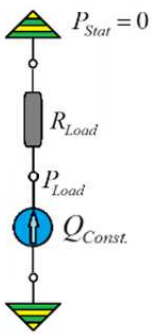

Fig.23 – Constant airflow

P_{Load} changes depending on R_{Load} and in figure 23 is shown the ideal behavior from a working point A to B. The step response in a real system when R_{Load} is suddenly increased first and then suddenly decreased to the starting value is shown in figure 23. The Sensorless Constant Airflow Algorithm of the fan works in terms of Speed (SX) and Power (WX).

STEP UP

- 1) At the beginning the duty point $A \rightarrow (S_A, W_A)$ corresponds to the defined airflow value Q_{const}
- 2) From A to A' the control had no enough time to react therefore the speed is the same
- 3) In A' the absorbed power is **lower** therefore $A' \rightarrow (S_A, W_{A'})$ corresponding to a different value of Q
- 4) The control increases the speed up to duty point $B \rightarrow (S_B, W_B)$ corresponding again to Q_{const} value

STEP DOWN

- 1) At the beginning the duty point $B \rightarrow (S_B, W_B)$ corresponds to the defined airflow value Q_{const}
- 2) From B to B' the control had no enough time to react therefore the speed is the same
- 3) In B' the absorbed power is **higher** therefore $B' \rightarrow (S_B, W_{B'})$ corresponding to a different value of Q
- 4) The control increases the speed up to duty point $A \rightarrow (S_A, W_A)$ corresponding again to Q_{const} value

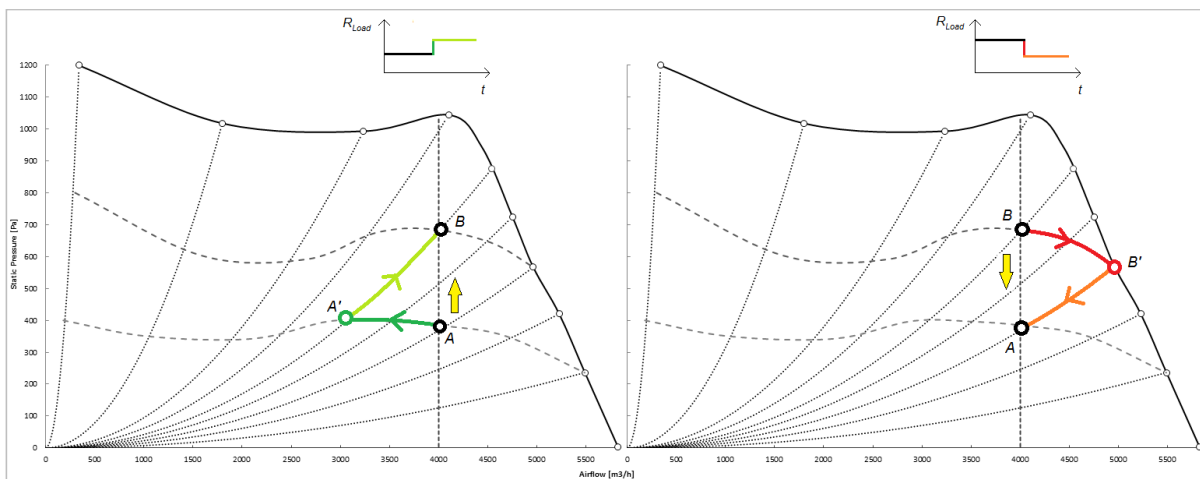

Fig.24 – Constant airflow behavior

Master&Slave considerations

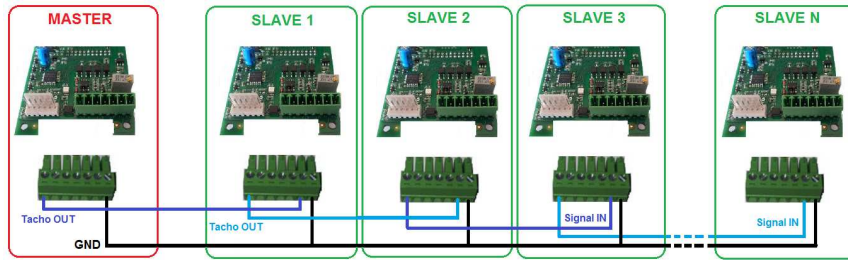
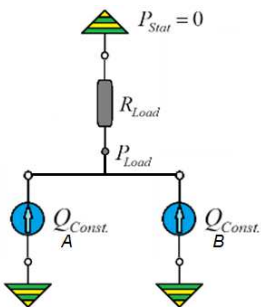

Fig.25 – Multiple Master&Slave connection

When two fans (A and B) are put in parallel configured in constant airflow mode and both blowing in the same plenum, they influence each other.



If the fan a is perturbed for any reason (ex. by obstructing the inlet cone) it behaves like the step up case from 1a to 2a, but meanwhile the b fan reacts as the step down case but (Fig.27) from 1b to 2b.

Fig.26 – Master&Slave

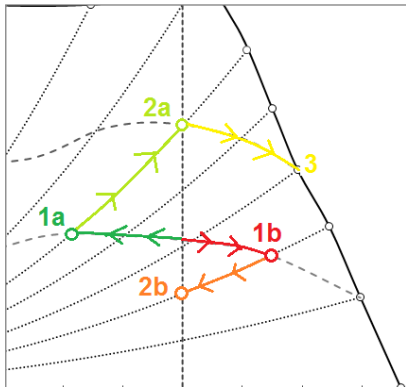

Fig.27 - Master&Slave fans behavior

When the obstruction is removed from point 3 the a fan would return to the starting point, but the two fans now interfere each other. The Master&Slave mode avoid this deep instability because the Master works in closed control loop while the Slave works in open loop driven by the master.

Characteristic of two forward curved fans in parallel at same speed

Two fans in parallel running at the same speed and blowing in the same plenum, work at the same pressure.

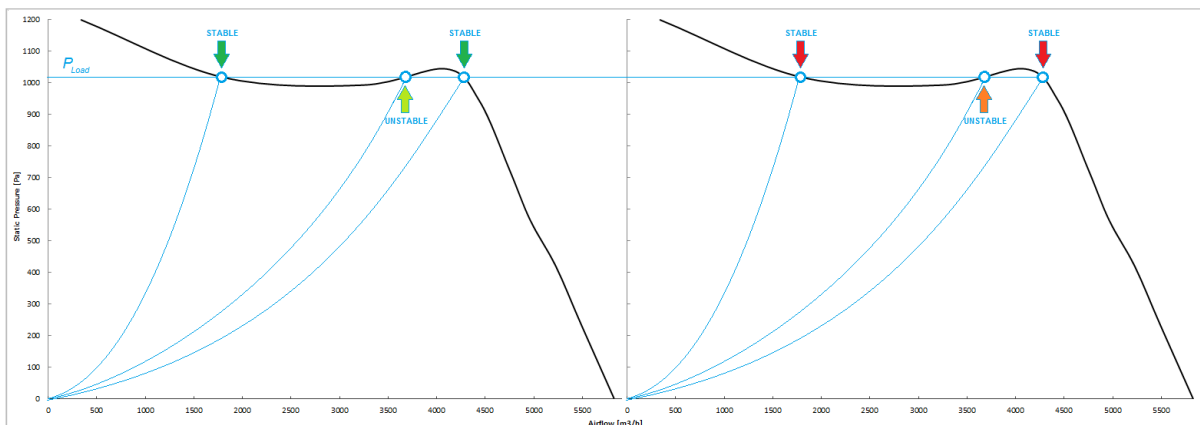
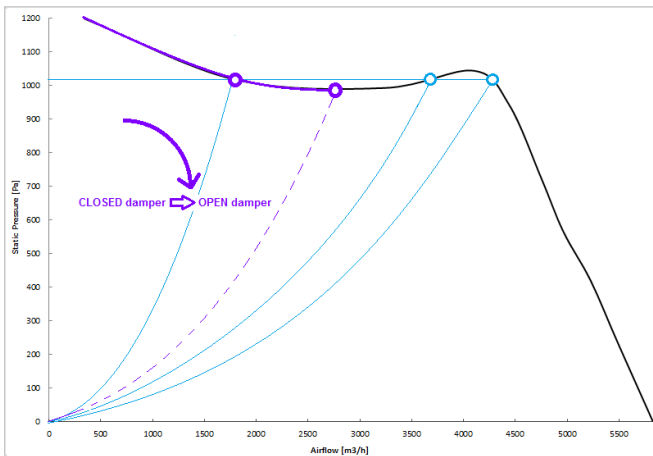

Fig.28 – Fans in parallel

Looking to the characteristic curve of a forward curved fan at the same pressure there are three possible airflow points for each fan: two stable points and the unstable inflection area.



Starting from a totally closed plenum damper to totally open, the two fans have the same load curve until the minimum pressure point and after that a perturbation could force the two fans to have two possible different states.

Fig.29 – Damper Totally Closed → Totally Open

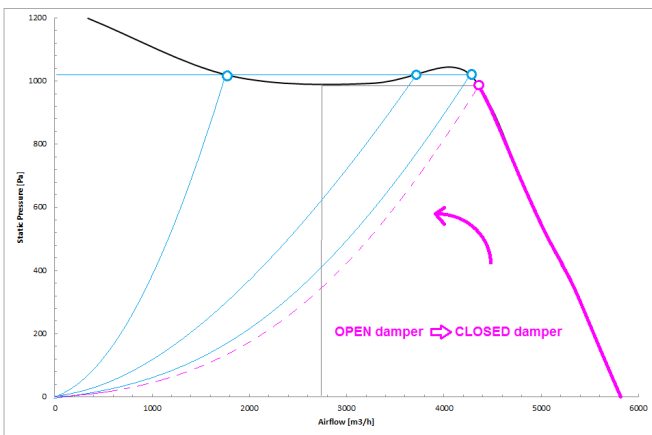

The same happens from totally open to totally closed plenum damper, but in this case the two fans have the same load curve until the point corresponding to the minimum pressure once again.

Fig.30– Damper Totally Open → Totally Closed

The previous assumption is true if the speeds of the two fans are the same.

If for some reasons the Slave is slower than the Master there is a unbalance condition forcing the system to a definite state as shown in figure 31

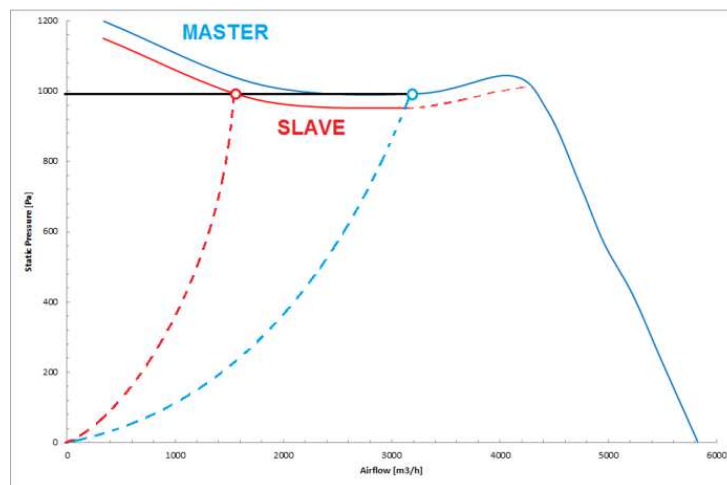

Fig. 31 – Master and Slave with different speeds

The same happens when the slave runs at higher speed, even if in this case the slave point is forced on the right

PID tuning procedure

Some fast rules to set the PID parameters are described in this paragraph.
(Closed loop Ziegler-Nichols method)

- 1) Set the parameter $Time = T_{PID}$ as a trade-off between:
 - a. Fast speed of response (which is favored by a small value of T_{PID})
 - b. Stability and robustness (which is favored by a large value of T_{PID})

The time must be higher than the delay of the fan $T_{PID} > \tau_{fan}$ and higher than the delay of the transducer connected to the fan $T_{PID} > \tau_{transducer}$.

The deceleration/acceleration ramp of the PFP can be read in the fig. 46 and considering an average value of 200 rpm/s the T_{PID} can be chosen starting from 5ms.

- 2) Rescale the max speed register basing on the limitation occurring in the final application or eventually verify the max voltage signal out from the transducer at the max fan speed.
- 3) In open loop set the fan speed at the desired performance and read the transducer voltage value (Fig.32)

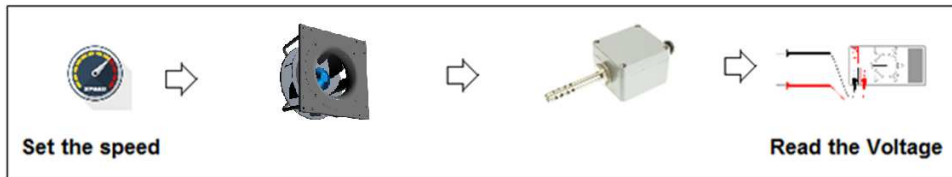

Fig. 32 – Find the PID Reference

- 4) Increase the $K_P = K_{osc}$ gain until the system starts oscillating. In fig. 33 the red line is the reference and the blue line is the transducer voltage value.

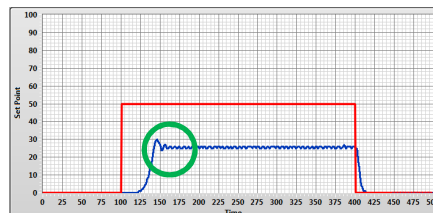

Fig. 33 – Oscillating System

- 5) Measure the oscillation N_{osc} occurring in $X_{Seconds}$ as shown in fig 34 (X can be chosen at

random). Considering that

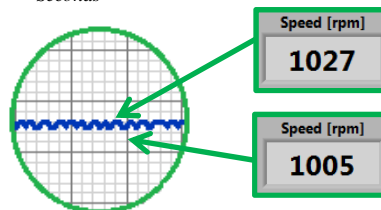

Fig. 34 – Measure of the oscillations

$$T_{osc} = \frac{X_{Seconds}}{N_{osc}}$$

- 6) Find the K_P, K_I and K_D using the table of fig 35 and considering that $T_I = \frac{K_P}{K_I}$ and $T_D = \frac{K_D}{K_P}$:

	K_P	T_I	T_D
Regulator P	$0.5 \cdot K_{osc}$		
Regulator PI	$0.45 \cdot K_{osc}$	$\frac{T_{osc}}{1.2}$	
Regulator PID	$0.6 \cdot K_{osc}$	$\frac{T_{osc}}{2}$	$\frac{T_{osc}}{8}$

Fig. 35 – Table of gains

NOTES

Nicotra Gebhardt worldwide

SPAIN

Ctra. Alcalá-Villar del Olmo, Km. 2,830
28810 Villalbilla-Madrid
Phone +34 918-846110
Fax +34 918-859450
E-mail info@nicotra.es

c/.Coso, 67-75, esc. 1.a,1.oB
50001 Zaragoza
Phone +34 976-290550
Fax +34 976-298127
E-mail gebhardt@teletel.es

BELGIUM

Haeghensgoed, 13 - 00/01
9270 Laarne
Phone +32 (0)9-336-00-01
Fax +32 (0)9-336-00-05
E-mail info.nicotra@nicotra.be

FRANCE

Leader's Park Bat A1
3 chemin des Cytises
69340 Francheville
Phone +33 (0)4 72 79 01 20
Fax +33 (0)4 72 79 01 21
E-mail g.cauche@nicotra-gebhardt.com

SWEDEN

Box 237
Kraketorpsgatan 30
43123 Mölndal
Phone 0046 31-874540
Fax 0046 31-878590
E-mail info.se@nicotra-gebhardt.com

GREAT BRITAIN

Unit D, Rail Mill Way
Parkgate Business Park
Rotherham
South Yorkshire
S62 6JQ
Phone +044 01709-780760
Fax +044 01709-780762
E-mail sales@nicotra.co.uk

UNITED STATES

PO BOX 900921
Sandy, Utah 84090
Phone 001(801) 733-0248
Fax 001(801) 315-9400
Mobile 001(801) 682 0898
E-mail mike.sehgal@gebhardtffans.com
<http://www.gebhardtffans.com/>



MALAYSIA

Lot 1799, Jalan Balakong
Taman Perindustrian Bukit Belimbing
43300 Seri Kembangan
Selangor
Phone +603 8961-2588
Fax +603 8961-8337
E-mail info_malaysia@nicotra-gebhardt.com

THAILAND

6/29 Soi Suksawadi 2, Moo 4, Suksawadi Road,
Kwang Jomthong, Khet Jomthong,
Bangkok 10150
Phone +662 476-1823-6
Fax +662 476-1827
E-mail sales@nicotra.co.th

SINGAPORE

No. 15 West Coast Highway
04-08 Pasir Panjang Building
Singapore 117861
Phone (065) 6265-1522
Fax (065) 6265-2400
E-mail info@gebhardt-singapore.com

AUSTRALIA

65 Yale Drive,
Epping, VIC 3076
Phone +61 3 9017 5333
Fax +61 3 8401 3969
E-mail info@nicotra.com.au

INDIA

Plot no 28F & 29, Sector-31, Kasna,
Greater Noida-201 308 U.P (India)
Phone +91 120 4783400
Phone +91 22 65702056 (Mumbai)
Phone +91 80 25727830 (Bangalore)
E-mail info@nicotraindia.com

CHINA

88 Tai'An Road, XinQiao, ShiJi, Panyu
Guangzhou 511450
PR CHINA
Phone +86 (0)20-39960570
Fax +86 (0)20-39960569
E-mail sales@nicotra-china.com

Nicotra Gebhardt Germany

Nicotra Gebhardt GmbH
Gebhardtstraße 19-25
74638 Waldenburg
Phone +49 (0)7942 101 0
Fax +49 (0)7942 101 170
E-mail info@nicotra-gebhardt.com

Nicotra Gebhardt Italy

Nicotra Gebhardt S.p.A
Via Modena, 18
24040 Zingonia (BG)
Phone +39 035 873 111
Fax +39 035 884 319
E-mail info@nicotra-gebhardt.com

nicotra-gebhardt.com