

# FDP FAN

## Operating Manual

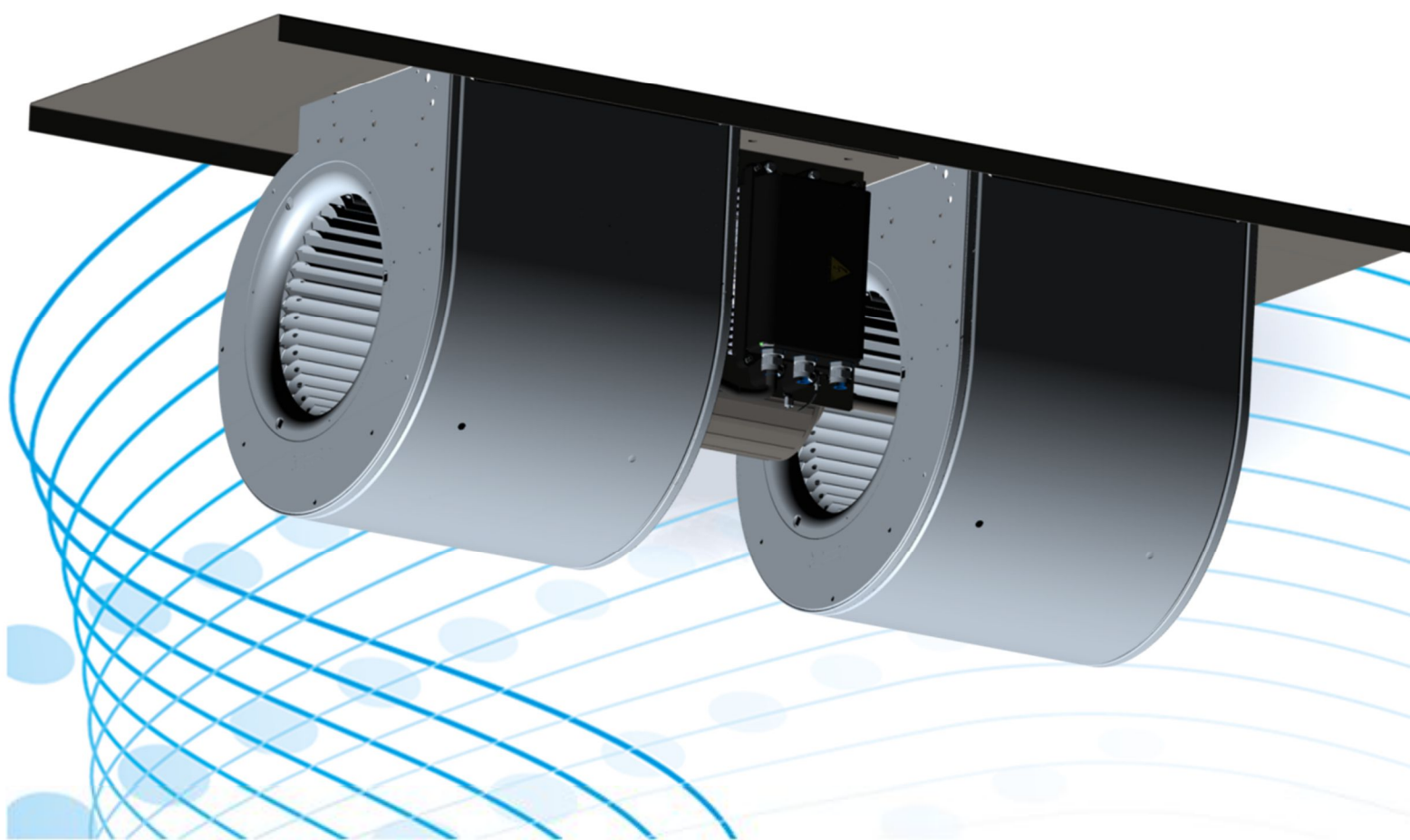

## TABLE OF CONTENTS

<b>1- DEFINITIONS AND WARNINGS</b>	<b>Pag.4</b>
1.0.1- Qualified Personnel	Pag.4
1.0.2- Use for intended purpose only	Pag.4
<b>1.1- Read carefully</b>	<b>Pag.4</b>
<b>1.2- Safety Instructions</b>	<b>Pag.5</b>
<b>1.3- General</b>	<b>Pag.5</b>
<b>1.4- Transport &amp; Storage</b>	<b>Pag.6</b>
<b>1.5- Commissioning</b>	<b>Pag.6</b>
<b>1.6- Operation</b>	<b>Pag.6</b>
<b>1.7- Repair</b>	<b>Pag.6</b>
<b>1.8- Declaration of conformity</b>	<b>Pag.7</b>
1.8.1- Electromagnetic Compatibility	Pag.7
<b>2- PRODUCT OVERVIEW</b>	<b>Pag.7</b>
2.0.1- General Information	Pag.7
2.0.2- Driver	Pag.7
2.0.3- Features	Pag.8
2.0.4- Performance	Pag.8
2.0.5- Protection	Pag.8
2.0.6- Ambient Operating Conditions	Pag.8
<b>3- CONNECTIONS</b>	<b>Pag.9</b>
3.0.1- Power supply connection:	Pag.9
3.0.2- Control Board connection:	Pag.9
<b>4- OPERATING MODES</b>	<b>Pag.11</b>
<b>4.1- Speed Control</b>	<b>Pag.12</b>
4.1.1- Analog Speed Control	Pag.12
4.1.2- Modbus Speed Control	Pag.12
4.1.3- Modbus Fixed Speed Control	Pag.12
4.1.4- Speed Control curves example	Pag.12
<b>4.2- Asynchronous Emulation</b>	<b>Pag.13</b>
4.2.1- Analog Asynchronous Emulation	Pag.13
4.2.2- Modbus Asynchronous Emulation	Pag.13
4.2.3- Modbus Fixed Asynchronous Emulation	Pag.13
4.2.4- Asynchronous Emulation curves example	Pag.13
<b>4.3- PID Closed Control Loop</b>	<b>Pag.14</b>
4.3.1- Analog Ref. PID Closed Control Loop	Pag.14
4.3.2- Modbus Ref. PID Closed Control Loop	Pag.14
4.3.3- Modbus Fixed Ref. PID Closed Control Loop	Pag.14
4.3.4- Modbus Positive/Negative feedback	Pag.14
4.3.5- PID tuning procedure	Pag.15

<b>5- ANALOG SIGNAL CONSIDERATION</b>	<b>Pag.16</b>
<b>6- OTHER FEATURES</b>	<b>Pag.17</b>
6.1- Signal Parallel	Pag.18
6.2- Master and Slave	Pag.18
6.3- Filters Alarm	Pag.19
6.4- Soft Start	Pag.19
6.5- Speed Limitation	Pag.20
6.6- Power Limitation	Pag.20
6.7- Current Limitation	Pag.20
6.8- Motor Voltage	Pag.20
6.9- Bus Voltage monitoring	Pag.20
6.10- Fan Efficiency	Pag.20
6.11- Driver Overheating: DERATING	Pag.21
6.12- Motor Overheating: THERMAL PROTECTOR	Pag.21
6.13- Fan Noise	Pag.21
<b>7- COMMUNICATION</b>	<b>Pag.22</b>
7.0.1- Protocol interface:	Pag.22
7.0.2- Baud rate	Pag.22
7.0.3- Parity and Stop bits	Pag.22
7.0.4- Supported Function:	Pag.22
7.0.5- Modbus Communication Timeout	Pag.22
7.0.6- Modbus Address	Pag.22
7.0.7- Broadcast Address	Pag.22
7.1- Holding Register (Volatile)	Pag.22
7.2- Holding Register (Permanent)	Pag.23
7.3- Holding Registers Description	Pag.24
7.4- Input Register Description	Pag.27
7.5- Modbus USB-RS485 converter	Pag.29
7.6- OFFLINE Cable	Pag.29
7.7- Bluetooth Connection	Pag.30
<b>8- ALARM HANDLING</b>	<b>Pag.30</b>
8.0.1- Monitoring:	Pag.30
8.0.2- Modbus Registers - Alarm description:	Pag.31
8.0.3- Led Blinking - Alarm description:	Pag.31
8.0.4- Digital Output	Pag.32
<b>9- AVAILABLE SOFTWARE</b>	<b>Pag.32</b>

## 1- DEFINITIONS AND WARNINGS



*For the purpose of this documentation and the product warning labels, "Warning" indicates that death, severe personal injury or substantial damage to property can result if proper precautions are not taken.*



*For the purpose of this documentation and the product warning labels, "Caution" indicates that minor personal injury or material damage can result if proper precautions are not taken.*

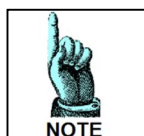

*Note For the purpose of this documentation, "Note" indicates important information relating to the product or highlights part of the documentation for special attention.*

### 1.0.1- Qualified personnel

For the purpose of this Instruction Manual and product labels, a "Qualified person" is someone who is familiar with the installation, mounting, start-up and operation of the equipment and the hazards involved. He or she must have the following qualifications:

- Trained and authorized to energize, de-energize, clear, ground and tag circuits and equipment in accordance with established safety procedures.
- Trained in the proper care and use of protective equipment in accordance with established safety procedures.
- Trained in rendering first aid.

### 1.0.2- Use for intended purpose only

The equipment may be used only for the application stated in the manual and only in conjunction with devices and components recommended and authorized by Nicotra Gebhardt.

## 1.1- Read carefully



*Before installing and commissioning the FDP fan, you must read all safety instructions and warnings carefully including all the warning labels attached to the equipment. Make sure that the warning labels are kept in a legible condition and replace missing or damaged labels.*

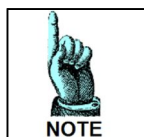

*Nicotra || Gebhardt reserves the right to change without notice.*

Information is also available from:

Nicotra Gebhardt S.p.A.  
Via Modena, 18  
24040 Ciserano Loc. Zingonia (BG)  
Italy

Telephon: +39 035 873 111

Telefax: +39 035 884 319

E-mail: [presales.italy@nicotra-gebhardt.com](mailto:presales.italy@nicotra-gebhardt.com)

## 1.2- Safety Instructions

The following warnings, cautions and notes are provided for your safety and as a means of preventing damage to the product or components at the connected machines. This section lists warnings, cautions and notes, which apply generally when handling the Nicotra Gebhardt Driver, classified as **General, Transport & Storage, Commissioning, Operation and Repair.**

**Specific warnings, cautions and notes** that apply to particular activities are listed at the beginning of the relevant chapters and are repeated or supplemented at critical points throughout these sections.

**Please read the information carefully, since it is provided for your personal safety and will also help prolong the service life of your FDP fan.**

## 1.3- General



*This equipment contains dangerous voltages and controls potentially dangerous rotating mechanical parts. Non-compliance with these warnings or failure to follow the instructions contained in this manual can result in loss of life, severe personal injury or serious damage to property.*

*Only suitable qualified personnel should work on this equipment, and only after becoming familiar with all safety notices, installation, operation and maintenance procedures contained in this manual. The successful and safe operation of this equipment is dependent upon its proper handling, installation, operation and maintenance.*

*Children and the general public must be prevented from accessing or approaching the equipment!*

*Risk of electric shock! The DC-BUS capacitors remain charged after mains supply has been switched off. It is not permissible to open the driver until 10 minutes after the mains supply has been removed.*



*This equipment may only be used for the purpose specified by the manufacturer. Unauthorized modifications and the use of spare parts and accessories that are not sold or recommended by the manufacturer of the equipment can cause fires, electric shocks and injuries.*

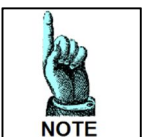

*Keep these operating instructions within easy reach of the equipment and make them available to all users. Whenever measuring or testing has to be performed on live equipment suitable electronic tools should be used.*

*Before installing and commissioning, please read these safety instructions and warnings carefully and all the warning labels attached to the equipment.*

*Make sure that the warning labels are kept in a legible condition and replace missing or damaged labels.*

## 1.4- Transport & Storage



*Correct transport, storage, erection and mounting, as well as careful operation and maintenance are essential for proper and safe operation of the equipment.*



*Protect the FDP fan against physical shocks and vibration during transport and storage. Also be sure to protect it against water (rainfall) and excessive temperatures.*

## 1.5- Commissioning



*Work on the device/system by unqualified personnel or failure to comply with warnings can result in severe personal injury or serious damage to material.*

*Only suitably qualified personnel trained in the setup, installation, commissioning and operation of the product should carry out work on the device/system.*

*This driver must be grounded.*

*The following terminals can carry dangerous voltages even if the Driver is inoperative:*

- *the power supply terminals L, N*
- *the motor terminals U, V, W*

## 1.6- Operation



*The driver must NOT be removed from the related FDP fan type and size.  
The driver can't be used separate from the related fan.*



*Ensure correct grounding connections. The ground cable must be sufficient to carry the maximum supply fault current which normally will be limited by the fuses or MCB. Suitably rated fuses or MCB should be fitted in the mains supply to the driver, according to any local legislation or codes.*



*The driver operates at high voltages.*

*Certain parameter settings may cause the driver to restart automatically after an input power failure.*

## 1.7- Repair



*Repairs on driver may only be carried out by Nicotra Gebhardt.*

*Before opening the driver for access, disconnect the power supply and wait for at least 10 minutes until the DC-BUS capacitor is completely discharged!*

## 1.8- Declaration of conformity

The FDP Driver product is conform to the relevant safety provisions of the Low Voltage Directive 2006/95/EC and the EMC Directive 2004/108/EC and has been designed and manufactured in accordance with the following harmonized European standards:

- **EN 61000-3-2 “Electromagnetic compatibility (EMC) - Part 3-2:** Limits - Limits for harmonic current emissions (driver input current  $\leq 16$  A per phase)”.
- **EN 61000-6-3 “Electromagnetic compatibility (EMC) - Part 6-3:** Generic standards - Emission standard for residential, commercial and light-industrial environments”.
- **EN 61000-6-4 “Electromagnetic compatibility (EMC) - Part 6-4:** Generic standards - Emission standard for industrial environments”.
- **EN 61800-3 EMC Product Standard for Power Drive Systems.**

### 1.8.1- Electromagnetic Compatibility

The FDP product is designed with high standards of EMC in mind. The Driver, suitable for use within the European Union, is fitted with an internal EMC filter. This EMC filter is designed to reduce the conducted emissions back into the supply through the power cables for compliance with harmonized European standards.

It is the responsibility of the installer to ensure that the equipment or system into which the product is incorporated complies with the EMC legislation of the country of use. Within the European Union, equipment into which this product is incorporated must comply with the EMC Directive 2004/108/EC.

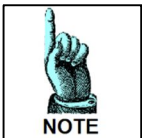

**To improve the Electromagnetic compatibility**  
**A ferrites model Wurth 742 717 22**  
**can be put on the power supply cable**  
**(close to the driver).**

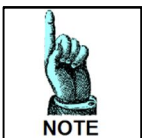

**The compliancy to the standards are intended for a single fan.**  
**No tests have been made on multiple installations.**

## 2- PRODUCT OVERVIEW

### 2.0.1- General Information

The FDP is a forward curved blade fan equipped by an internal permanent magnet rotor motor. The Driver is compact and it's directly installed on board of the fan. It is equipped with an active PFC (Power Factor  $> 0.95$  in any state of operation) and it drives the motor through a sensorless algorithm.

### 2.0.2- Driver

In the figure 1 is shown the Driver and its parts.



Fig. 1 – FDP Driver front and side view

## 2.0.3- Features

- Supply voltage 220V-240V +/-10% (50/60Hz)
- Sinusoidal Sensorless control
- Integrated active Power Factor Controller
- Simple cable connection with cage clamps
- Integrated Modbus RTU interface
- Integrated analogue interface 0-10V
- Tachometric output available

## 2.0.4- Performance

- Asynchronous Mode Emulation
- Internal PID available
- Soft start
- Adjustable limits and operating mode
- Self-protecting strategies implemented
- High efficiency
- NTC bypassed during operation
- PFC disabled at stop
- 1.1 kW maximum input power
- Power Factor >0.95

## 2.0.5- Protection

- Missing phase protection
- Short circuit protection
- Overload protection
- Overheat protection
- Impeller blocking protection
- Safe Operating Area (speed, power and current limitation)

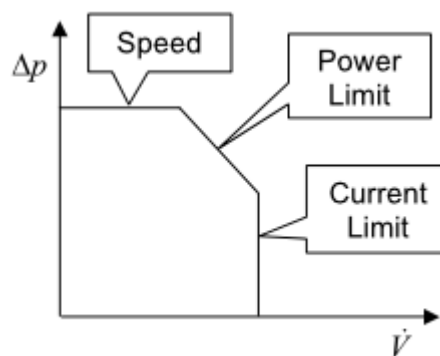

Fig. 2 – Safe Operating Area

## 2.0.6- Ambient Operating Conditions

- Protection Class: IP 32
- Humidity Range: 90% non-condensing
- Altitude: if the fan is to be installed at an altitude > 1000m, derating is required.
- Shocks: do not drop the fan or expose it to sudden shock.
- Vibration: do not install the fan in an area where it is likely to be exposed to constant vibrations.



## 3- CONNECTIONS



**Work on the driver/fan by unqualified personnel or failure to comply with warnings can result in severe personal injury or serious damage to material.**

**Only suitably qualified personnel trained in the set-up, installation, commissioning and operation of the product should carry out work on the driver/fan. This driver must be grounded.**

**The following terminals can carry dangerous voltages even if the driver is inoperative:**

- the power supply terminals L, N
- the motor terminals U, V, W

The FDP driver connections are shown in figure 3.

- The motor is already connected to the driver by the Nicotra | Gebhardt operators
- The end user has to connect the power supply cable
- The end user has to connect the command signal to the control board

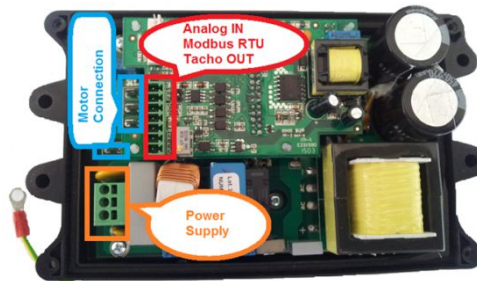

Fig. 3 –Driver connection terminals



**The grounding cable/metal strip connecting the Driver to the side plate of the driver must not be disconnected.**

### 3.0.1- Power supply connection:

Single Phase 220/240V ±10% @ 50/60Hz

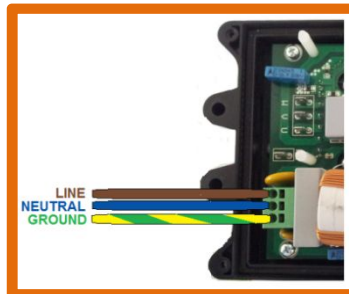
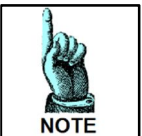

Fig.4



**The performance in the range [200V-264V] @ 50Hz/60Hz is always the same due to the PFC module inside the driver!**

### 3.0.2- Control Board connection:

As default the Driver is programmed for an analog input command of 0-10V (Fig. 5).

The analog input can accept also a PWM signal with  $f > 1\text{kHz}$ .

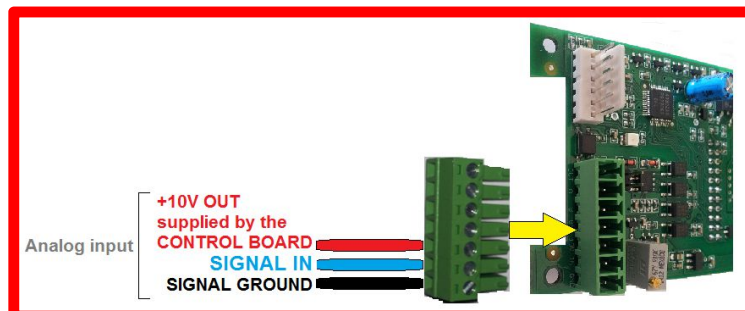

Fig. 5 – Driver – CONTROL BOARD analog connection

In figure 6 is shown the Modbus connection diagram.

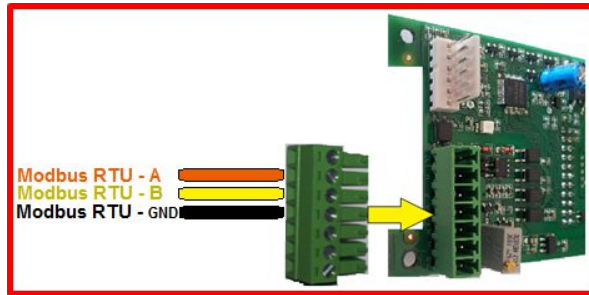
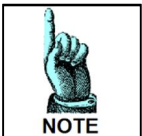

Fig.6 – Driver – CONTROL BOARD Modbus connection



**Don't use devices having the signal GND connected to the NEUTRAL cable of the power supply. The driver may be damaged or not functioning properly.**



**To set the speed through the Modbus protocol is necessary to set a dedicated register (Input Type – HOLDING REGISTER 34 see “Modbus communication” paragraph )**

In figure 7 is shown how to connect the tachometric output.

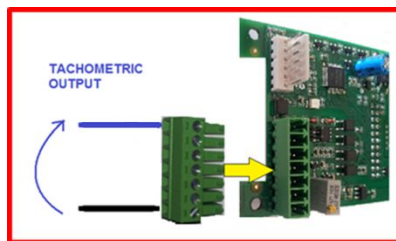
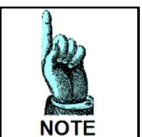

Fig.7 – Driver – CONTROL BOARD tachometric output connection

The tachometric output is a 0 to 5V PWM waveform at 1KHz with the following duty cycle:

$$Duty\ Cycle\ (Speed) = \begin{cases} 0\% & 0 \leq Speed < Speed_{min} \\ 10\% + \frac{90\% \cdot (Speed_{Real} - Speed_{min})}{Speed_{MAX} - Speed_{min}} & Speed \geq Speed_{min} \end{cases}$$



**Remember that the  $Speed_{Real}$  is 0 below  $Speed_{min}$**



**The +10V power supply available of the Driver is intended to be used with a potentiometer of minimum 2KOhm. Any different devices connected to it could bring to an undesired functioning of the Driver or the connected device. The absorbed current must be <5mA.**



**Don't reverse the input signal or connect the +10V to signal ground. The Driver could be damaged.**

**Don't apply signals with voltage higher than 10V. The Driver could be damaged.**

## 4- OPERATING MODES

The FDP fan has 3 possible **Operating Modes**:

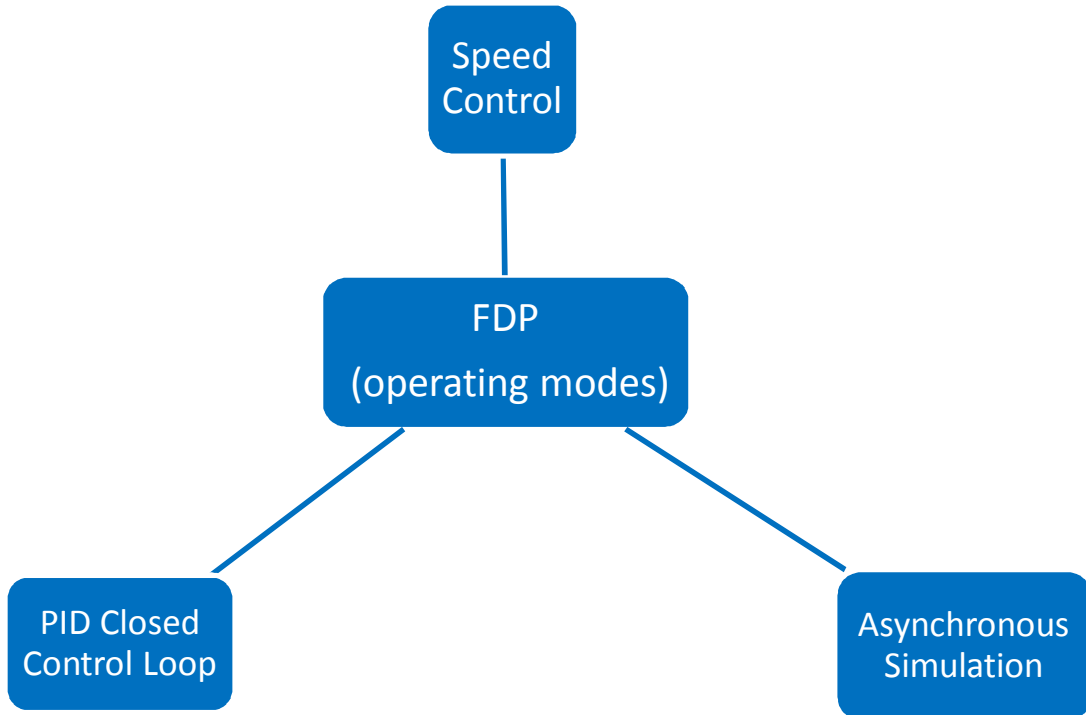

Fig.8

For each mode there are 3 possible **Setting Options**:

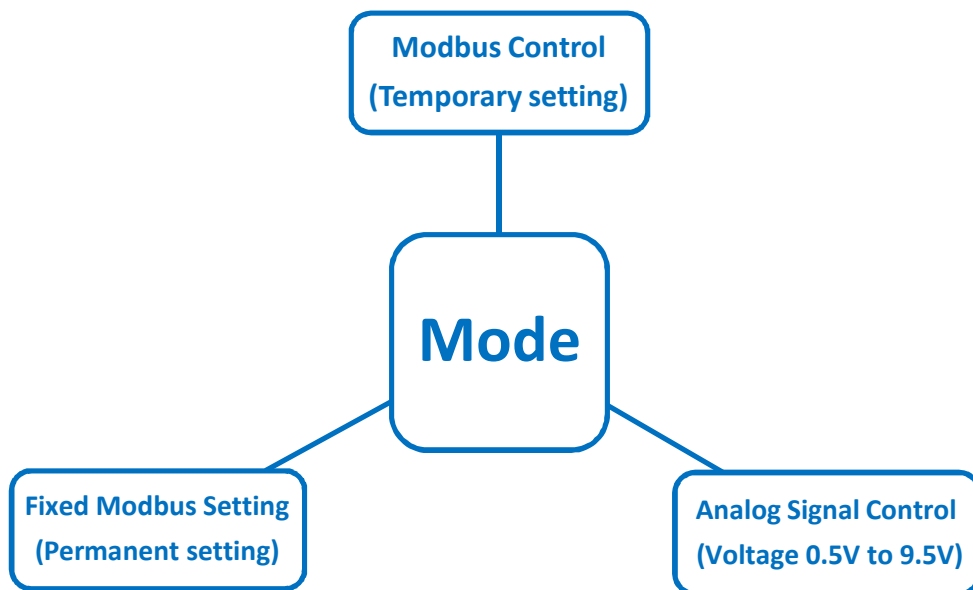

Fig.9

The operating modes and the setting options can be chosen by modifying the INPUT TYPE  Holding Register 34

## 4.1- Speed Control

### 4.1.1- Analog Speed Control (*INPUT TYPE = 1 Default factory setting*)

Through this setting the fan speed is proportional to the analog voltage input fig. 10. The fan speed is limited by the Safe Operating Area (see Fig. 2 Page 8) therefore, depending on the fan working point, the fan could be no more able to increase the speed coherently to the set voltage value.

To avoid the loss of signal dynamic, it is necessary a speed limits rescaling by modifying the value of the Max Speed Holding Register 2. It is also possible to rescale the min Speed by modifying the Holding Register 1.

The analog signal can be read from the Input Register 14.

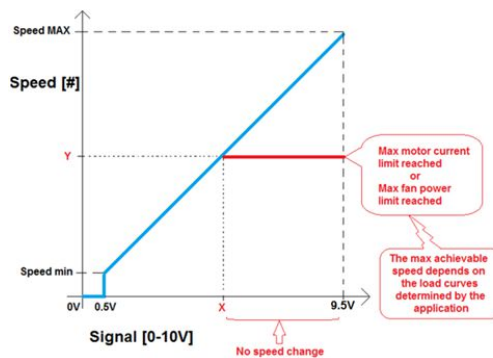

Fig.10 – Analog signal-Speed relationship.

The MAX and min speed default values are in function of the fan sizes .

### 4.1.2- Modbus Speed Control (*INPUT TYPE = 0*)

Through this setting the fan runs at the speed defined by modifying the Holding Register 66.

The setting is maintained meanwhile the fan is powered on and it is lost when the fan is powered off.

### 4.1.3- Modbus Fixed Speed Control (*INPUT TYPE = 2*)

Through this setting the fan runs at the speed defined by modifying the Holding Register 21.

The setting is permanent and fan starts at the defined speed each time it is powered on.

### 4.1.4- Speed Control curves example

In figure 11 it is shown a set of performance curves at different speed settings limited by the fan max working limit curve (see Safe Operating Area)

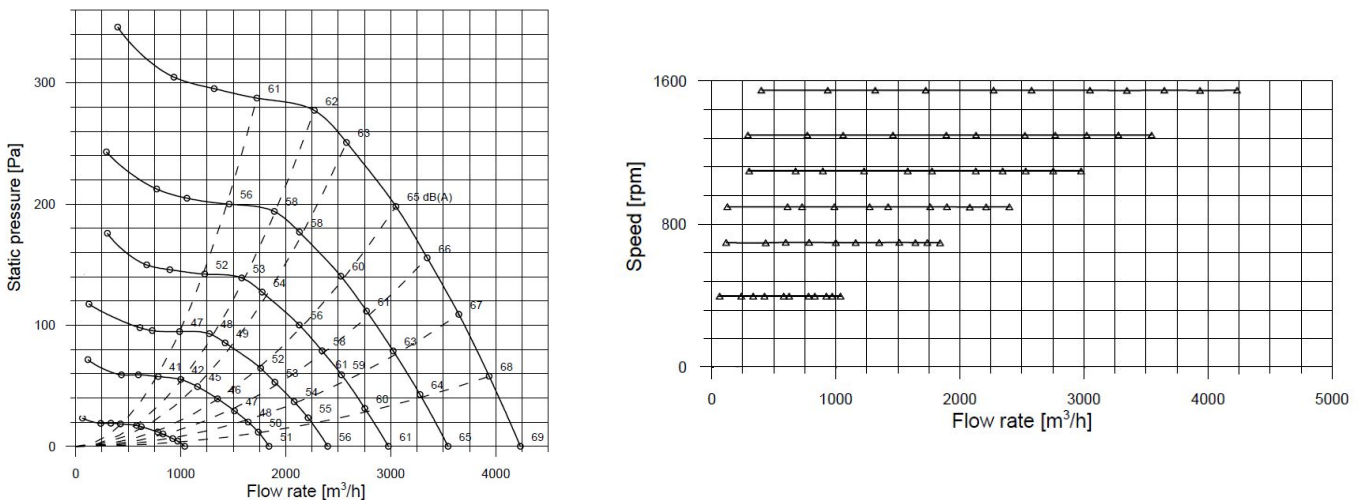

Fig.11 – Speed control curves - PERFORMANCE and SPEED

## 4.2- Asynchronous Emulation

Through this mode there is the possibility to emulate the behavior of an asynchronous induction motor with a slip and a power limitation dependent on the load and speed (therefore there could be some differences from each size).

The control is expressed in percentage instead of a defined measure of unit.

The lower is the slip the higher is the performance and vice versa.

### 4.2.1- Analog Asynchronous Emulation (**INPUT TYPE = 7**)

Through this setting the slip is proportional to the analog voltage input and the relationship is shown in fig. 12.

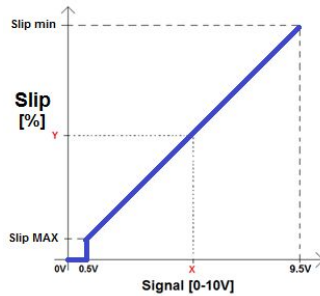

Fig. 12 – Analog Signal-Asynchronous Emulation relationship

### 4.2.2- Modbus Asynchronous Emulation (**INPUT TYPE = 8**)

Through this setting the fan emulate an ACIM motor and the slip is defined by modifying the [Holding Register 66](#). The setting is maintained meanwhile the fan is powered on and it is lost when the fan is powered off.

### 4.2.3- Modbus Fixed Asynchronous Emulation (**INPUT TYPE = 9**)

Through this setting the fan emulate an ACIM motor and the slip is defined by modifying the [Holding Register 30](#). The setting is permanent and fan starts at the defined constant slip each time it is powered on.

### 4.2.4- Asynchronous Emulation curves example

In figure 13 are shown 5 curves with the following slip percentage: 100%, 80%, 60%, 40% and 20%

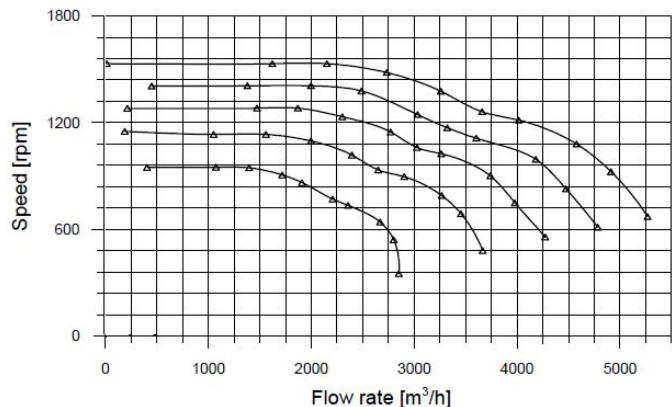
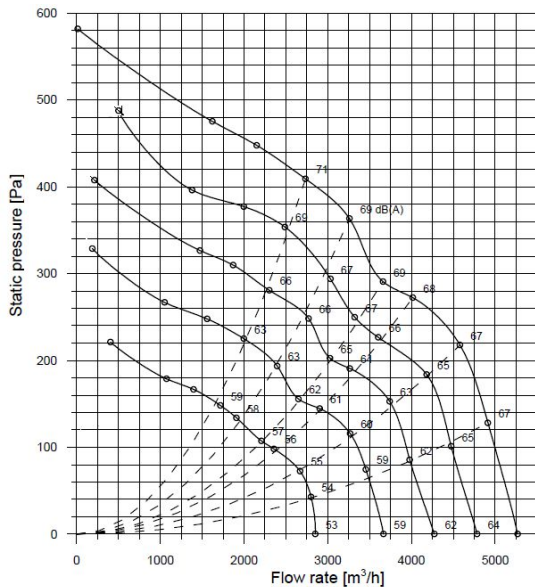

Fig.13 – Asynchronous Emulation curves – PERFORMANCE and SPEED

## 4.3- PID Closed Control Loop

Through this setting the fan is able to work in a PID closed control loop where the measured process variable is connected to the analog input and it must be in the range of [0,10V]

The PID mode can be therefore used with temperature probes, pressure transducer, CO/CO<sub>2</sub> detectors, etc.

The parameters to set are:

- $K_p$  = Proportional Gain Holding Register 51
- $K_I$  = Integral Gain Holding Register 52
- $K_D$  = Derivative Gain Holding Register 53
- $Time = T_{PID}$  Holding Register 54

Here in the following the simplified PID code:

$$Error = (R_{reference} - M_{easure});$$

$$P_{roportional} = K_p \cdot Error; \quad I_{ntegral} + = K_I \cdot Error \cdot T_{PID}; \quad D_{erivative} = \frac{K_D (Error_n - Error_{n-1})}{T_{PID}};$$

$$Error_{n-1} = Error_n; \quad R_{esult} = P_{roportional} + I_{ntegral} + D_{erivative};$$

### 4.3.1- Analog Ref. PID Closed Control Loop (INPUT TYPE = 10)

This mode is not available on FDP fans because there is only one analog input.

### 4.3.2- Modbus Ref. PID Closed Control Loop (INPUT TYPE = 11)

Through this mode the PID reference is defined by modifying the Holding Register 66.

The value of the reference is expressed in steps of 0.1Volt (therefore the register ranges from 0 to 100)

The PID error is calculated in the following way:  $Error = (Modbus_{REG\_66} - ANALOG_{Input})$

### 4.3.3- Modbus Fixed Ref. PID Closed Control Loop (INPUT TYPE = 12)

Through this mode the PID reference is defined by modifying the Holding Register 50.

The value of the reference is expressed in units of 0.1Volt (therefore the register ranges from 0 to 100)

The PID error is calculated in the following way:

$$Error = (Modbus_{REG\_50} - ANALOG_{Input})$$

### 4.3.4- Modbus Positive/Negative feedback

Depending on the application it could be necessary to invert the feedback behavior (Fig.14).

Through the Holding Register 31 it is possible to multiply by -1 the PID error.

When the register is set to 0 →  $Error = (R_{reference} - M_{easure});$

When the register is set to 1 →  $Error = (M_{easure} - R_{reference});$

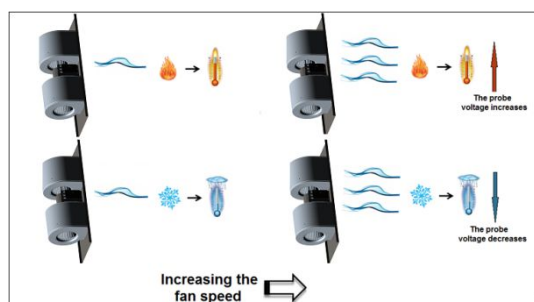

Fig. 14 – Example of positive/negative feedback coefficient

## 4.3.5- PID tuning procedure

In this paragraph are described some fast rules to set the PID parameters.  
 (Here it is described the closed loop Ziegler-Nichols method)

- 1) Set the parameter  $Time = T_{PID}$  as a trade-off between:
  - a. Fast speed of response (which are favored by a small value of  $T_{PID}$ )
  - b. Stability and robustness (which are favored by a large value of  $T_{PID}$ )

The time must be higher than the delay of the fan  $T_{PID} > \tau_{fan}$  and higher than the delay of the transducer connected to the fan  $T_{PID} > \tau_{transducer}$ .

The deceleration/acceleration ramp of the FDP can be read in the fig. 46 and considering an average value of 200 rpm/s the  $T_{PID}$  can be chosen starting from 5ms.

- 2) Rescale the max speed register basing on the limitation occurring in the final application or eventually verify the max voltage signal out form the transducer at the max fan speed.
- 3) In open loop set the fan speed at the desired performance and read the transducer voltage value (Fig.15)

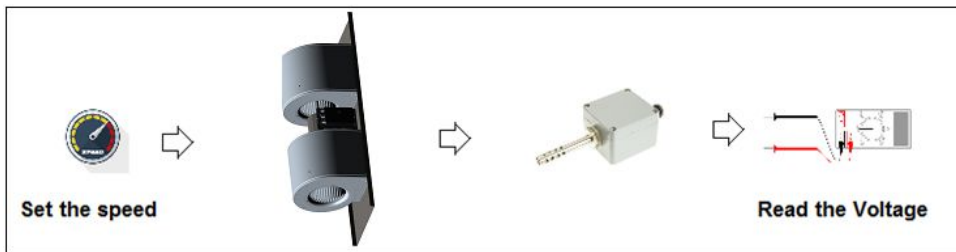

Fig. 15 – Find the PID Reference

- 4) Increase the  $K_p = K_{osc}$  gain until the system starts oscillating. In fig. 16 the red line is the reference and the blue line is the transducer voltage value.

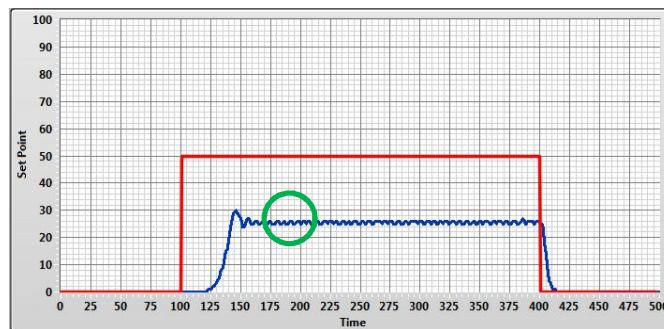

Fig. 16 – Oscillating System

- 5) Measure the oscillation  $N_{osc}$  occurring in  $X_{Seconds}$  as shown in fig 17 (X can be chosen at random).

Considering that 
$$T_{osc} = \frac{X_{Seconds}}{N_{osc}}$$

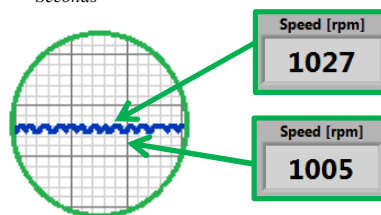

Fig. 17 – Measure of the oscillations

6) Find the  $K_P$ ,  $K_I$  and  $K_D$  using the table of fig 18 and considering that  $T_I = \frac{K_P}{K_I}$  and  $T_D = \frac{K_D}{K_P}$ :

	$K_P$	$T_I$	$T_D$
<b>Regulator P</b>	$0.5 \cdot K_{occ}$		
<b>Regulator PI</b>	$0.45 \cdot K_{occ}$	$\frac{T_{occ}}{1.2}$	
<b>Regulator PID</b>	$0.6 \cdot K_{occ}$	$\frac{T_{occ}}{2}$	$\frac{T_{occ}}{8}$

Fig. 18 – Table of gains

In the figure 19 is shown the behavior of the PID regulator with 3 different  $T_{PID}$

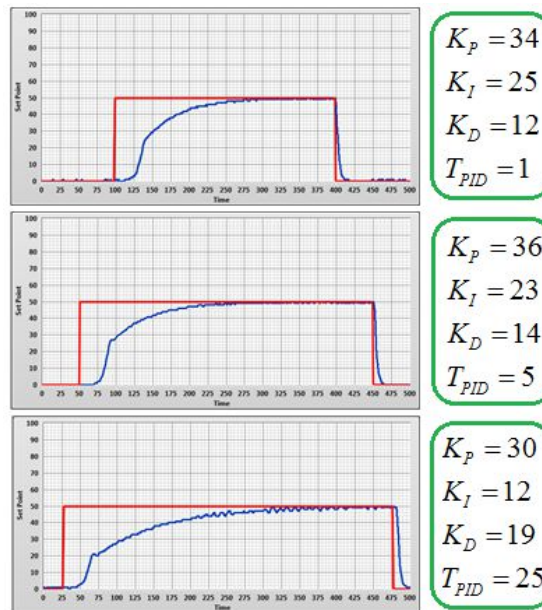

Fig. 19 – PID with 3 different  $T_{PID}$  values

## 5- ANALOG SIGNAL CONSIDERATION

In this paragraph is shown the way for finding the  $V_{req}$  (voltage required) for achieving the  $Speed_{Desired}$  using the diagram Sig./Speed (fig.20)

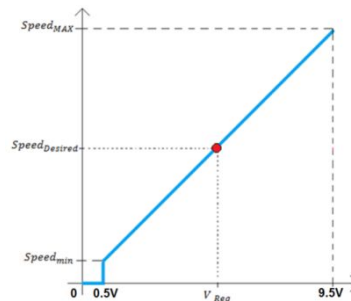

Fig.20 – Analog Signal

$$V_{req} = \frac{Speed_{Desired} - Speed_{min}}{Speed_{MAX} - Speed_{min}} \cdot 9V + 0.5V$$

$$PotentiometerValue = Pot_{val} = R_1 + R_2 \geq 2K\Omega$$

$$Input_{IMPEDANCE} = 20K\Omega$$



$$V_{req} = \frac{200K\Omega \cdot R_2}{Pot_{Val} \cdot (20K\Omega + R_2) - R_2^2} \quad \text{while with N fan in parallel } V_{req} = \frac{200K\Omega \cdot R_2}{Pot_{Val} \cdot (20K\Omega + NR_2) - NR_2^2}$$

$$\text{Therefore } R_2 = \frac{Pot_{Val} \cdot V_{req} - 200K\Omega + \sqrt{(200K\Omega - V_{req} \cdot Pot_{Val})^2 + 80K\Omega \cdot V_{req}^2 \cdot Pot_{Val}}}{2 \cdot V_{req}}$$

In figure 21 is shown the behavior of the analog voltage signal increasing the potentiometer value and the behavior increasing the number of fans in parallel.

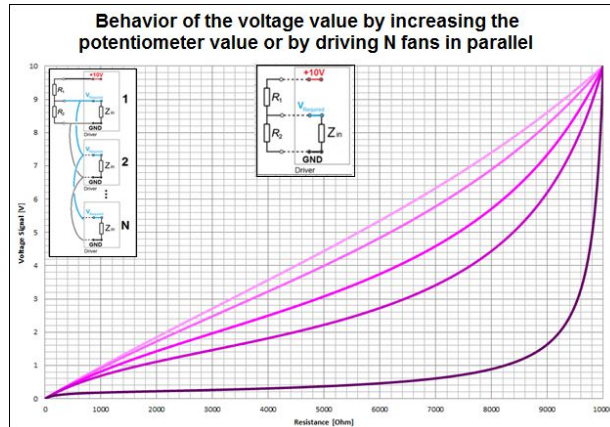

Fig.21 – Analog voltage behavior increasing the potentiometer value or increasing the fan in parallel

The final result for the user is an higher sensibility of the command for small changes of the potentiometer position.

## 6- OTHER FEATURES

The FDP has several **Other Features** as shown in fig.22.

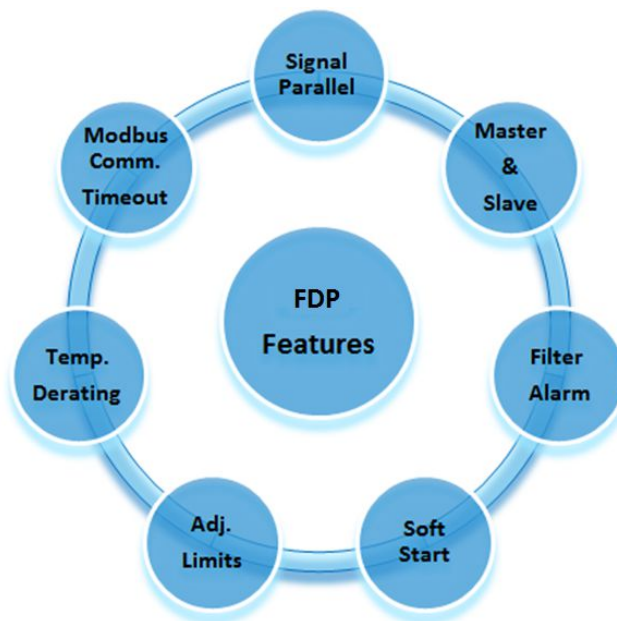

Fig.22

## 6.1- Signal Parallel

If two or more fans are installed in the same compartment it is important that they start at the same time, otherwise the first fan running forces the other to run in backward rotation.

The FDP fans are able to start with a low backward rotation (speed < 200rpm), but they stop if the backward rotation is higher due to the built-in auto-protection feature.

With the signal parallel this problem can be avoided (Fig. 23)

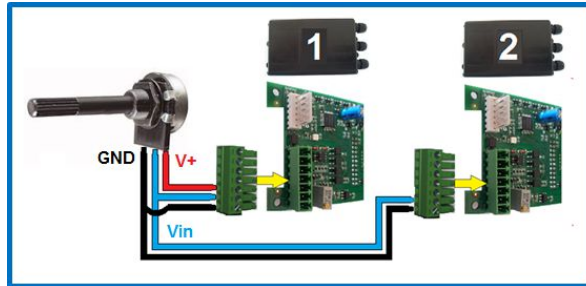

Fig. 23 – SPEED CONTROL - PARALLEL Connection

Nicotra||Gebhardt can supply a dedicated potentiometer: REGPOT code K43138 In figure 24 is shown the connection diagram (with stop function or without).

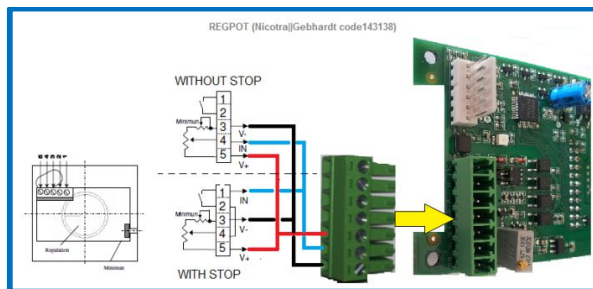

Fig. 24 – Nicotra || Gebhardt potentiometer –REGPOT

## 6.2- Master and Slave

It is possible to drive two fans in a master and slave configuration by setting the MASTER in one preferred mode and the SLAVE in Speed Control mode only.

The SLAVE operating mode must be changed (**INPUT TYPE = 3**)

The MASTER must have the *Holding Register 46* set at 0 = TACHO.

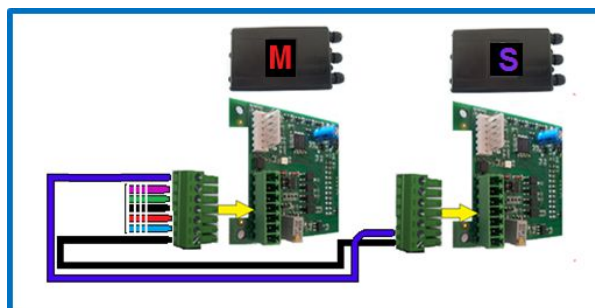

Fig. 25 – MASTER/SLAVE connection

This function is useful for example when two fans work in Asynchronous Emulation and it is required that both fans run at the same speed.

## 6.3- Filters Alarm

This feature is interesting when used in Asynchronous emulation (see figures 26).

When the filters become dirty in the two previous mode the fan speed increases, therefore a speed threshold can be used to identify this situation.

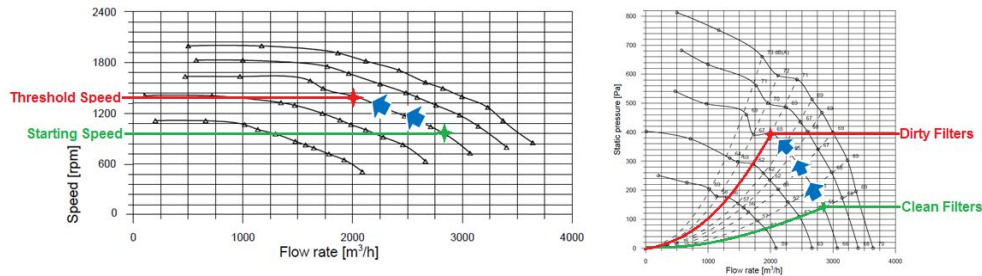

Fig. 26 – Asynchronous emulation - FILTERS DIRTY

To activate this feature the Holding Register 46 must be set at value 2 and then the required Speed Threshold value must be set into the Holding Register 55.

The digital output of the driver changes its status as shown in the fig 27.

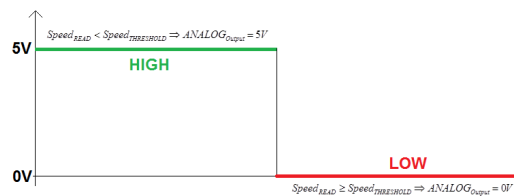

Fig. 27 – Threshold Speed - Analog Output behavior

## 6.4- Soft Start

In the following paragraph it is shown the starting phase of a FDP fan.

- The first phase when the fan receives a command to start running is the ALIGNMENT. During this phase the driver aligns the rotor. (If there is a cause making the fan rotating in the opposite direction with a speed lower than 200rpm, the fan is actually able to brake the wheel and proceed with the alignment) This phase takes 1 second.
- The second phase is the dragging phase, where the fan gradually increases its speed to the minimum in open loop. In this phase the current and speed values present in the Input Register can't be taken in consideration. This phase takes 8 seconds.
- The last phase is the closed loop where the sensorless control is active and from the minimum speed to the target speed the fan accelerates with different ramps basing on the fan size and the wheel inertia. The acceleration and deceleration values are different and in particular to avoid overvoltage alarm or loss of synchronism alarm, the deceleration is always lower.

The Input Register 2 indicates the Speed Reference (minimum speed during alignment and dragging and the Set Speed in Closed Control Loop)

The Input Register 3 indicates the Measured Speed.

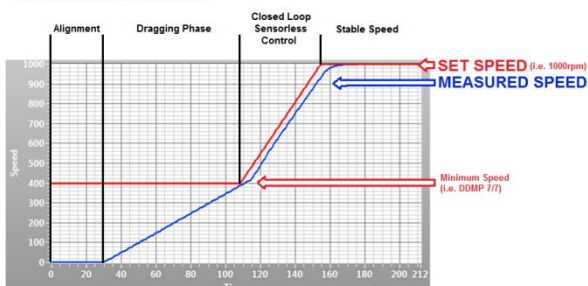

Fig. 28 – Starting phase of a FDP

## 6.5- Speed Limitation

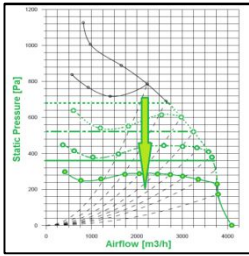

Fig. 29

The speed limits can be adjusted for the signal rescaling as explained in the paragraph 4.1, but also to limit the noise in the final application.

In figure 29 it is shown the performance reduction when the power limitation is decreased.

## 6.6- Power Limitation

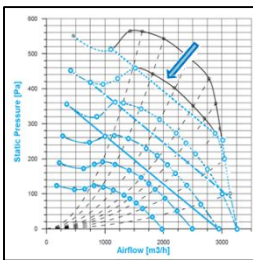

Fig. 30

The FDP Drivers are set by factory default to the max achievable power out to the motor that is 1.05kW.

During the functioning it is possible to monitor the instant power absorption by reading the [Input Register 32](#). If for some application it is necessary to keep the absorption of the fan below a defined power value, it is possible to reduce the max power out by modifying the [Holding Register 36](#). In figure 30 it is shown the performance reduction when the power limitation is decreased.

## 6.7- Current Limitation

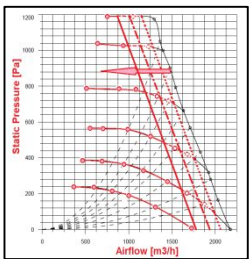

Fig. 31

The FDP Drivers are set by factory default to the max peak motor current out that changes depending on the motor windings characteristics.

During the functioning it is possible to read the peak motor current to the motor by reading the [Input Register 12](#). It is possible to reduce the motor current by modifying the [Holding Register 7](#). It is suggested to keep the motor current above the 1500mA.

In figure 31 it is shown the performance reduction when the power limitation is decreased.

## 6.8- Motor Voltage

To complete the motor parameters overview it is possible to read the voltage out by reading the [Input Register 13](#)

## 6.9- Bus Voltage monitoring

The PFC inside the driver increases the rectified input voltage up to 380V.

The Bus Voltage value can be monitored by reading the [Input Register 9](#).

## 6.10- Fan Efficiency

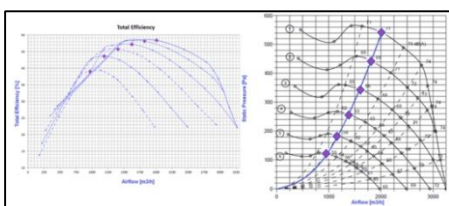

Fig.32 – FDP Total Efficiency

All the FDP range is compliant to the ErP requirements.

In figure 32 it is shown the efficiency in function of the airflow at several different speeds.

## 6.11- Driver Overheating: DERATING

When the temperature of the Driver components overtakes a fixed threshold of 75°C the Driver automatically reduces the performance in order to decrease the heating. It is possible to check in real time the driver temperature by reading the [Input Register 15](#)

If it is not possible to reach a steady thermal equilibrium, the Driver shuts down. The protection acts limiting the current to the motor .

In this condition the driver goes in alarm (see the Alarm Handling chapter)

Once the temperature on the driver decreases under 75°C the driver automatically reset the alarm and it restarts functioning.

## 6.12- Motor Overheating: THERMAL PROTECTOR

The motor is protected through a Thermal Protector.

If the motor temperature is too high the thermal protector opens one phase and the Driver recognizes the error and it stops the fan (see the Alarm Handling chapter).

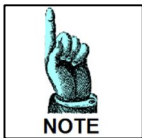

***The Motor Winding temperature and the Driver derating are dependent on the fan size and on the fan working point.  
Therefore it is possible that the fan could work at 50°C without a performance limitation***

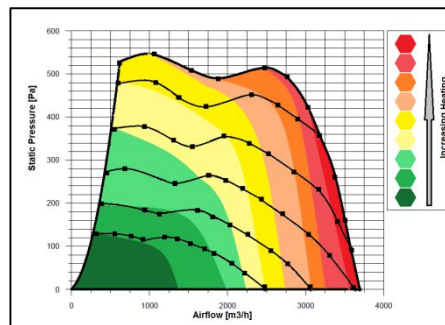

Fig.33 – FDP thermal behavior



***The Driver and motor areas rated for operating in a temperature range between -20°C and +40°C. The derating is tested and guaranteed from +40°C to +50°C .  
Higher temperatures could damage the motor winding or the performance could be strongly reduced.***

## 6.13- Fan Noise

In figure 34 is shown the indicative distribution of the Sound Pressure Level of a FDP model .

The FDP fans can reach high speed compared to the std. AC fans, therefore it's important to evaluate the speed at the required performance to avoid noise problems

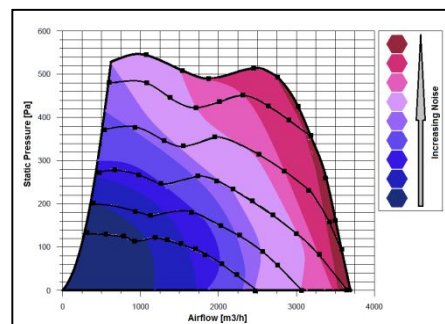

Fig.34 – FDP Noise distribution – Sound Pressure Level

## 7- COMMUNICATION

### 7.0.1- Protocol interface:

MODBUS RTU (RS485 or Bluetooth)

### 7.0.2- Baud rate

The baud rate can be set through the  Holding Register 47  and the possible speed are:

**Modbus RTU:** 9.6kbps and 19.2kbps (higher speed are not allowed due to the board Opto-Insulators)

**Bluetooth:** 9.6kbps, 19.2kbps, 38.4kbps and 57.6kbps.

### 7.0.3- Parity and Stop bits

The parity and the stop bits can be chosen by modifying the  Holding Register 48  and the possible choices are:

- 0 = No parity, 2 stop bits (Default)
- 1 = Odd parity, 1 stop bit
- 2 = Even parity, 1 stop bit

### 7.0.4- Supported Function:

- 03 – Read Holding Register
- 04 – Read Input Register
- 06 – Write Single Holding Register
- 16 – Write Multiple Holding Register

### 7.0.5- Modbus Communication Timeout

With this feature is possible to stop the fan when the communication is lost, after a period of time set in the  Holding Register 56 . The register can be set to:

- 0 – No Communication Timeout
- 1 to 32767 – time expressed in second, therefore it is possible to set from 1sec to 9h 6m 8 sec.

When the timeout occurs the driver goes in alarm condition and the communication must be restored and the alarm must be cleared.

The alarm is indicated in the Input register 17 with the value of 255 (0xFF).

### 7.0.6- Modbus Address

The slave device address can be changed from value 1 to 247 by modifying the  Holding Register 45 .

### 7.0.7- Broadcast Address

The Broadcast address is 0. The default address from factory configuring is 1.

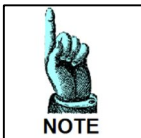

***To make the Modbus changing effective the driver must be powered off and power on again.***

## 7.1- Holding Register (Volatile)

The  Holding Register 66  is a special register used in each operating mode for setting the speed, the slip and the PID reference.

It is not a physical register and it can be written, but it is not possible to read its value.

The setting remains active meanwhile the fan is powered on.

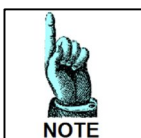

***If the fan is powered off but there is a residual charge, the microcontroller of the driver is still functioning. Therefore if is powered on in this situation the value set through the register 66 is still active.***

## 7.2- Holding Register (Permanent)

The physical FDP Holding Registers are 64 and in fig.35 is shown the description and the parameters loaded into the fan models as factory default.

Only green registers can be written by the final user, while the others are covered by password and can be modified only by Nicotra | Gebhardt technicians.

REG.	Description	FDP 200x190 1413H3 1kW	FDP 200x240 1413H3 1kW	FDP 9/7 1413H3 1kW	FDP 9/9 1413H3 1kW	FDP 200x190 1413G6 1kW	FDP 180x240 1413G6 1kW
0	Reset	0	0	0	0	0	0
1	Min Speed	400	400	400	400	400	400
2	Max Speed	1550	1550	1550	1550	1550	1550
3	Acceleration	150	150	150	150	150	150
4	Deceleration	80	80	80	80	80	80
5	Pole Couples	4	4	4	4	4	4
6	Startup Current	1500	1500	1500	1500	1188	1188
7	Max Current	3850	3850	3850	3850	2450	2450
8	Stator Resistance	457	457	457	457	788	788
9	Synch. Inductance	45	45	45	45	74	74
10	P.M. Flux	3030	3030	3030	3030	2582	2582
11	Current Kp	1467	1467	1467	1467	2359	2359
12	Current Ki	6954	6954	6954	6954	15097	15097
13	Speed Kp	4000	4000	4000	4000	4000	4000
14	Speed Ki	100	100	100	100	100	100
15	Flux fb. Gain	50	50	50	50	10	10
16	Phase Offset	0	0	0	0	0	0
17	Startup Time	800	800	800	800	800	800
18	Flux est. filter tau	10	10	10	10	10	10
19	Sampling Freq.	8000	8000	8000	8000	8000	8000
20	Freq. Ratio	2	2	2	2	2	2
21	Fixed speed setting	0	0	0	0	0	0
22	Max. blocking current	1000	1000	1000	1000	1000	1000
23	Min. blocking current	250	250	250	250	250	250
24	Blocking time	200	200	200	200	200	200
25	Alignment current	1500	1500	1500	1500	1188	1188
26	Alignment time	100	100	100	100	100	100
27	Id Fall time	50	50	50	50	50	50
28	Id ref	0	0	0	0	0	0
29	Max temp	750	750	750	750	750	750
30	Asynchronous Slip	0	0	0	0	0	0
31	PID Pos/Neg	0	0	0	0	0	0
32	Avoid range start	20000	20000	20000	20000	20000	20000
33	Avoid range end	20000	20000	20000	20000	20000	20000
34	Input type	1	1	1	1	1	1
35	Stop speed	20000	20000	20000	20000	20000	20000
36	Maximum Power	1050	1050	1050	1050	1050	1050
37	Power Kp	2000	2000	2000	2000	2000	2000
38	Power Ki	1500	1500	1500	1500	1500	1500
39	Constant Airflow	0	0	0	0	0	0
40	Kp Flow	0	0	0	0	0	0
41	Ki Flow	0	0	0	0	0	0
42	Min Airflow	0	0	0	0	0	0
43	Max Airflow	0	0	0	0	0	0
44	Fan Model	1	2	3	4	5	6
45	Modbus Addr	1	1	1	1	1	1
46	Tach OUT	0	0	0	0	0	0
47	Modbus Speed	96	96	96	96	96	96
48	Modbus Stop Bits	0	0	0	0	0	0
49	Max Input Current	0	0	0	0	0	0
50	External Set	0	0	0	0	0	0
51	Kp ext	0	0	0	0	0	0
52	Ki ext	0	0	0	0	0	0
53	Kd ext	0	0	0	0	0	0
54	PID Time	0	0	0	0	0	0
55	Speed Threshold	0	0	0	0	0	0
56	Communication Timeout	0	0	0	0	0	0
57	Limit RPM min	400	400	400	400	400	400
58	Limit RPM max	1550	1550	1550	1550	1550	1550
59	Limit I OUT	3850	3850	3850	3850	2450	2450
60	Limit P MAX	1050	1050	1050	1050	1050	1050
61	Limit I INPUT	0	0	0	0	0	0
62	Date	0	0	0	0	0	0
63	Serial	0	0	0	0	0	0

Fig.35 – Holding Registers



*The Holding Register handling limits as 1,2,7,36,42 and 43 must be set with the fan stop. Changing the parameters during functioning may cause unexpected behavior.*

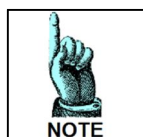

*The registers 39, 42 and 43 can be written, but the constant airflow function is not available*

## 7.3- Holding Registers Description

### **Holding Register 0:** RESET [Adim] **(Default = 0)**

This register can be used to reset the fan by writing the value 1 on it and putting the analog input to 0V. The driver will reset any error condition and it will try to restart.



**Don't write other values than 1.**

**Other values could reset all the registers to a neutral configuration and must be sent back to Nicotra | Gebhardt for a reconfiguring.**

Range: 0 or 1

### **Holding Register 1:** Min Speed [RPM] **(Default = min value for each fan type)**

This register is used to set the minimum speed of the fan.

Range:  $400rpm \leq MinSpeed \leq 1000rpm$

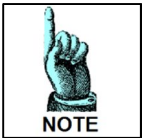

**The min speed must be set below the max achievable speed depending on the application and the working point.**

### **Holding Register 2:** Max Speed [RPM] **(Default = max value for each fan type)**

This register can be used to set the max speed of the fan.

(For special application the max possible limits could be reviewed only by Nicotra | Gebhardt technicians)



**Don't set the Min Speed higher than the Max Speed otherwise the driver stops working without any alarm indication!**

Range:  $MinSpeed < MaxSpeed \leq 1550rpm$

### **Holding Register 7:** Max Current [mA] **(Default max value for each fan type)**

This register can be used to reduce the max motor current.

(For special application the max possible limits could be reviewed only by Nicotra | Gebhardt technicians)

Range:  $1500mA \leq MaxCurrent \leq \begin{cases} 2450mA \\ 3850mA \end{cases}$  depending on the fan size

### **Holding Register 21:** Fixed Speed setting. [RPM] **(Default = 0)**

This register can be used to set a fixed speed.

The register is active when the Input Type Holding Register 34 is set to the value 2.

Type of setting= PERMANENT

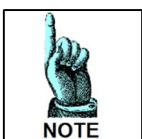

**When another operating mode is selected, this register should be put at 0 value.**

Range:  $MinSpeed < MaxSpeed \leq 1550rpm$



**Holding Register 30:** Asynchronous Slip. [%] **(Default = 0)**

This register can be used to set the slip of an emulated ACIM motor.  
 The register is active when the Input Type Holding Register is set to the value 9.  
 Type of setting= PERMANENT

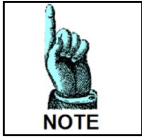

**When another operating mode is selected, this register should be put at 0 value.**

Range:  $0\% \leq \text{AsynchronousSlip} \leq 100\%$

**Holding Register 34:** Input Type [Adim] **(Default = 1 → Analog Speed Control)**

This register defines all the possible operating modes:

- |   |   |
|---|---|
| 0- <u>Modbus Speed Control:</u>                       | The speed is set by modifying the register 66 (volatile)            |
| 1- <u>Analog Speed Control:</u>                       | The speed is set through the analog signal                          |
| 2- <u>Modbus Fixed Speed Control:</u>                 | The speed is set by modifying the register (permanent)              |
| 3- <u>Master &amp; Slave:</u>                         | The fan is configured as slave and follows the speed of the master. |
| 4- <u>Analog Constant Airflow:</u>                    | NOT AVAILABLE ON FDP  |
| 5- <u>Modbus Constant Airflow:</u>                    | NOT AVAILABLE ON FDP  |
| 6- <u>Modbus Fixed Constant Airflow:</u>              | NOT AVAILABLE ON FDP  |
| 7- <u>Analog Asynchronous Emulation:</u>              | The emulation is set through the analog signal                      |
| 8- <u>Modbus Asynchronous Emulation:</u>              | The emulation is set by modifying the register 66 (volatile)        |
| 9- <u>Modbus Fixed Asynchronous Emulation:</u>        | The emulation is set by modifying the register 30 (permanent)       |
| 10- <u>Analog Ref. PID Closed Control Loop:</u>       | NOT AVAILABLE ON FDP (Second Analog input not present)              |
| 11- <u>Modbus Ref. PID Closed Control Loop:</u>       | The PID ref. is set by modifying the register 66 (volatile)         |
| 12- <u>Modbus Fixed Ref. PID Closed Control Loop:</u> | The PID ref. is set by modifying the register 50 (permanent)        |

Range:  $0 \leq \text{InputType} \leq 12$



**When the Input Type value is moved on Modbus mode, the fan stops.**  
**When the Input Type value is moved on a Fixed mode or an Analog mode, the fan changes its behavior basing on the target put into the registers 21, 30, 50 or the analog signal present.**

**Holding Register 36:** Maximum Power [W] **(Default = max value for each driver type)**

This register can be set for reducing the power out to the motor.  
 (For special application the max possible limits could be reviewed only by Nicotra | Gebhardt technicians)

Range 1kW driver:  $100W \leq \text{MaximumPower} \leq 1050W$

**Holding Register 44:** **Fan Model [Adim]**

This register can be only read and it gives an important information about the configuration of the fan loaded into the driver.

This register combined with the **Input Register 0** and the **Input Register 1** can be used to check if the fan configuration is correct.

Range:  $1 \leq \text{FanType} \leq 6$

## **Holding Register 45:** Modbus Address [Adim] **(Default = 1)**

This register can be used to change the Modbus address of a driver.

Range:  $1 \leq ModbusAddress \leq 247$

## **Holding Register 46:** Tachometric/ Alarm/Threshold [Adim] **(Default = 0)**

This register can be used to set the digital output function.

The possible settings are:

- 0- *Tachometric:* The digital output indicates the measured speed through a PWM signal.
- 1- *Alarm:* The digital output indicates when an alarm occur.
- 2- *Threshold:* The digital output indicates when the speed set in the *Holding Register 55* is overtaken

Range: 0 or 1 or 2

## **Holding Register 47:** Modbus Speed [ $10^{-1}$ kbps] **(Default = 96)**

This register can be used to set the Modbus speed.

Range:

- 96 → corresponding to 9.6kbps
- 192 → corresponding to 19.2kbps
- 384 → corresponding to 38.4kbps (not available using the opto-insulated terminal block)
- 576 → corresponding to 57.6kbps (not available using the opto-insulated terminal block)

Values outside the nominal ones will be coerced to a correct value.

## **Holding Register 48:** Modbus Stop Bits [Adim] **(Default = 0)**

This register can be used to set the parity and the stop bits.

Range:

- 0: 2 Stop Bits/No Parity
- 1: 1 Stop Bit/Even Parity
- 2: 1 Stop Bit/Odd Parity

## **Holding Register 50:** External Set [ $10^{-1}$ V] **(Default = 0)**

This register can be used to set the reference of the PID control.

The register is active when the Input Type Holding Register is set to the value 12.

Type of setting= PERMANENT

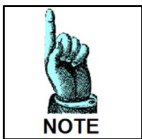

**When another operating mode is selected, this register should be put at 0 value.**

Range:  $0V \leq ExternalSet \leq 100 \times 10^{-1} V$

## **Holding Register 51:** Kp [Adim] **(Default = 0)**

This register can be used to set the Proportional Gain of the PID control.

Range:  $0 \leq K_p \leq 32767$

## **Holding Register 52:** Ki [Adim] **(Default = 0)**

This register can be used to set the Integral Gain of the PID control.

Range:  $0 \leq K_i \leq 32767$

## **Holding Register 53:** Kd [Adim] **(Default = 0)**

This register can be used to set the Derivative Gain of the PID control.

$$\text{Range: } 0 \leq K_D \leq 32767$$

## **Holding Register 54:** Period [ms] **(Default = 0)**

This register can be used to set the time constant of the PID control.

$$\text{Range: } 0 \leq T_{PID} \leq 32767$$

## **Holding Register 55:** Speed Threshold [RPM] **(Default = 0)**

This register can be used to set the speed threshold. When the measured speed in the [Input Register 3](#) overtakes the threshold value.

Speed Threshold =0 means that it is **DEACTIVATED**

$$\text{Range: } 0 \leq \text{SpeedThreshold} \leq \text{MaxSpeed}$$

## **Holding Register 56:** Communication Timeout [s] **(Default = 0)**

This register can be used to set a timeout period for the communication. At the end of the period set into the register the fan stops and an Alarm2 indication 0xFF.

To restart a reset command must be sent.

Communication Timeout =0 means that it is **DEACTIVATED**

$$\text{Range: } 0 \leq \text{CommunicationTimeout} \leq 9h8m8s$$

## 7.4- Input Register Description

The Modbus Input Registers shown in fig. 36 are in total 33 but only the underlined ones are useful for the user.

REG	Description	
<u>0</u>	<u>Firmware Version</u>	[Adim]
<u>1</u>	<u>Driver Model</u>	[Adim]
<u>2</u>	<u>Speed Reference</u>	[rpm]
<u>3</u>	<u>Measured Speed</u>	[rpm]
4	Imposed Frequency	[Hz]
5	Direct Current	[mA]
6	Quadrature Current	[mA]
7	Direct Voltage	[10 <sup>-1</sup> V]
8	Quadrature Voltage	[10 <sup>-1</sup> V]
<u>9</u>	<u>Bus Voltage</u>	[10 <sup>-1</sup> V]
<u>10</u>	<u>Alarm (1)</u>	[Adim]
11	Flags	[Adim]
<u>12</u>	<u>Motor Current</u>	[mA]
<u>13</u>	<u>Motor Voltage</u>	[10 <sup>-1</sup> V]
<u>14</u>	<u>Analog Input</u>	[10 <sup>-1</sup> V]
<u>15</u>	<u>Module Temperature</u>	[10 <sup>-1</sup> °C]
16	Not Used	---
<u>17</u>	<u>Alarm (2)</u>	[Adim]
18	Mode	[Adim]
19	Stator Resistance	[10 <sup>-1</sup> Ohm]
20	Synchronous inductance	[10 <sup>-1</sup> mH]
21	P.M. flux	[10 <sup>-1</sup> mWb]
22	Current Loop kp	[Adim]
23	Current Loop ki	[Adim]
24	PWM frequency	[Hz]
25	Sampling frequency	[Hz]
26	Extra Flags	[Adim]
27	Digital Input	[Adim]
28	Analog Input 0	x 10V/2 <sup>16</sup>
29	Analog Input 1	x 10V/2 <sup>16</sup>
30	Analog Input 2	x 10V/2 <sup>16</sup>
<u>31</u>	<u>Measured Power</u>	[W]
32	Input Current AVG	[mA]

Fig.36– Input Registers

**Input Register 0:** Firmware Version [Adim]

This register indicates the firmware uploaded into the FDP driver.

This register combined with the Input Register 1 and the Holding Register 44 can be used to check if the fan configuration is correct.



**All the features indicated in this manual are referred to a firmware Revision 5 or higher**

**Input Register 1:** Driver Type [Adim]

This register indicates the driver type that for the FDP is 41505

This register combined with the Input Register 0 and Holding Register 44 can be used to check if the fan configuration is correct.

**Input Register 2:** Speed Reference [rpm]

This register indicates the speed reference during the functioning. During the starting phase is equal the Min Speed and then gradually increases to the target speed depending on the selected mode.

Range:  $MinSpeed \leq Speed_{REFERENCE} \leq MaxSpeed$

**Input Register 3:** Measured Speed [rpm]

This register indicates the speed during the functioning.

Range:  $0 \leq MeasuredSpeed \leq MaxSpeed$

**Input Register 9:** Bus Voltage [ $10^{-1}V$ ]

This register indicates the rectified voltage after the PFC stage.

Driver OFF-Fan OFF:  $0V$

$$\text{Driver ON-Fan OFF: } V_{AC} \cdot \sqrt{2} = \begin{cases} 283V \longrightarrow \text{min} \\ 325V - \text{Default} \\ 373V \longrightarrow \text{MAX} \end{cases} \quad \text{Driver ON-Fan ON: } 385V$$

**Input Register 10:** Alarm1 [Adim]

This register must be combined with the Alarm2 register (see the alarm lookup table)

Range:  $0 \leq Alarm1 \leq 4$

**Input Register 12:** Motor Current [mA]

This register indicates the peak value of the line current module [A]. To know the rms value, has to be divided by  $\sqrt{2}$ .

Range:  $0 \leq MotorCurrent \leq MaxCurrent$  depending on the fan sizes

**Input Register 13:** Motor Voltage [ $10^{-1}V$ ]

This register indicates the peak value of the phase voltage module [V]. To know the rms line to line value, has to be multiplied by  $\sqrt{3}/2$ .

Range:  $0V \leq MotorVoltage \leq 2250 \cdot 10^{-1}V$

**Input Register 14:** Analog Input [ $10^{-1}V$ ]

This register indicates the analog voltage value present at the input.

Range:  $0V \leq ANALOG_{Input} \leq 100 \cdot 10^{-1}V$

**Input Register 15:** Module Temperature [ $10^{-1}^{\circ}C$ ]

This register indicates the temperature of the power module of the driver. When the value exceeds  $75^{\circ}C$  the driver enters in a derating process where the performance are automatically decreased until a thermal equilibrium below  $75^{\circ}C$  is reached.

If this equilibrium is not reached the fan stops and an alarm condition is activated. As soon as the heating decreases and the power module temperature is below  $75^{\circ}C$ , the alarm is automatically reset.

**Input Register 17:** Alarm2 [Adim]

This register must be combined with the Alarm1 register (see the alarm lookup table)

Range:  $0 \leq Alarm2 \leq 255$

**Input Register 31:** Measured Power [W]

This register indicates the absorbed power.

Range:  $0 \leq MeasuredPower \leq MaximumPower$  depending on the fan sizes

## 7.5- Modbus USB-RS485 converter

As accessory it's possible to use a Nicotra | Gebhardt USB-RS485 converter code K431A7(see fig. 37)

The drivers for **CP210x\_VCP\_Windows** can be downloaded at

<https://www.silabs.com/products/mcu/Pages/USBtoUARTBridgeVCPDrivers.aspx>



Fig.37 – USB-RS485

## 7.6- OFFLINE Cable

It is possible to configure the FDP Driver in an offline mode by using a dedicated cable (Nicotra | Gebhardt code K431A6).

(Cable specifications: **USB to TTL Serial Cable 5V**. Drivers available at [Http://ftdichip.com](http://ftdichip.com) )

In fig. 38 is shown the particular of the OFFLINE connector with the description of the pins.



Fig.38 – White OFFLINE connector and OFF line Cable



**During the OFFLINE operation the driver MUST BE DISCONNECTED FROM POWER SUPPLY or could be damaged or destroyed.**

## 7.7- Bluetooth Connection

It is possible to use the OFFLINE connector even if the driver is powered on, but the device connected to it must be floating and not accessible by the end user.

In fact the power supply of the OFFLINE connector is 5V but directly obtained from the bus line without opto-insulators. A very small Bluetooth module that is suitable for this application is the HC-06 module for Arduino applications fig. 39 (Refer to the HC-06 manufacturer for datasheet and configuration).

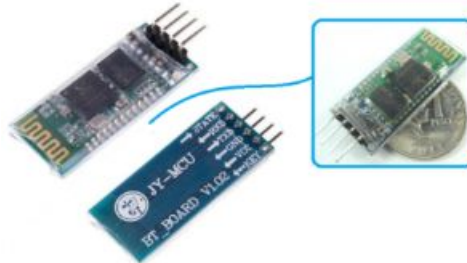

Fig.39 – HC-06 module

In figure 40 are shown the connection.

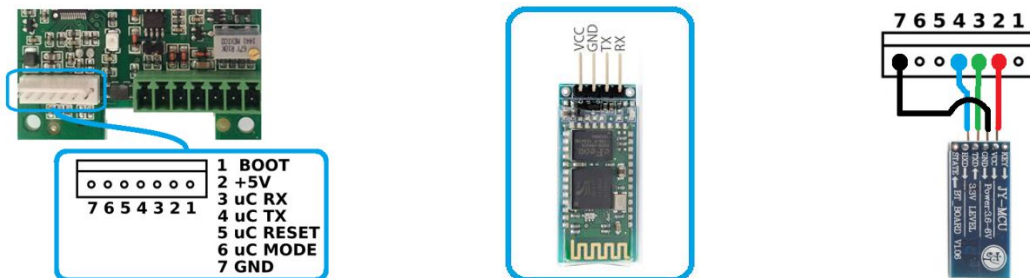

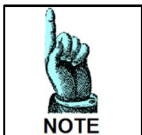

Fig.40 – Connections

**Note:** an available  Google Play freeware App is CDE: Bluetooth Serial Communication 



**With Bluetooth devices the EMC is not guaranteed.**

## 8- ALARM HANDLING

When a malfunctioning occurs the driver has two possible behaviors depending on the cause of the alarm:

- 1) **BLOCKING**                      The cause of the alarm is very dangerous → The driver stops immediately. To restart the fan, once the problem is corrected, it is necessary to reset the fan or power the driver off for 5 minutes.
- 2) **AUTO-RESTARTING**            The cause of the alarm is contingent to a wrong setting or wrong working condition. The alarm indications are activated, but after some seconds the fan tries to restart automatically

### 8.0.1- Monitoring:

The alarms can be monitored through three different ways:

- a) Modbus Registers
- b) LED blinking
- c) Digital Output

## 8.0.2- Modbus Registers - Alarm description:

In fig.41 are indicated the possible alarms and the values stored in the related Modbus Input Register 10 and Input Register 17.

Alarm1	Alarm2	Description	Actions
0	0	Normal operation, no errors	<b>NO ACTIONS</b>
1	0	Memory error	<b>BLOCKING</b>
2	0	Short-circuit	<b>BLOCKING</b>
3	0	Loss of synchronism with the motor	<b>AUTO-RESTARTING</b>
4	1	Input voltage outside range (only with motor stopped)	<b>AUTO-RESTARTING</b>
4	32	Bus voltage over 430V during operation (instantaneous measurement)	<b>AUTO-RESTARTING</b>
4	33	Bus voltage below 350V during operation (instantaneous measurement)	<b>AUTO-RESTARTING</b>
4	34	Input relay not closed	<b>AUTO-RESTARTING</b>
4	49	Motor cable U disconnected	<b>BLOCKING</b>
4	50	Motor cable V disconnected	<b>BLOCKING</b>
4	51	Motor cable W disconnected	<b>BLOCKING</b>
4	113	Overtemperature	<b>AUTO-RESTARTING</b>
4	255	Loss of Communication	<b>BLOCKING</b>

Fig. 41 – Alarm description



**An occurring alarm with NO ACTIONS could imply a dangerous functioning anyway. The Driver is NOT protected against a very high power supply voltage. A very low power supply voltage during the motor running could damage Driver**

## 8.0.3- Blinking Led - Alarm description:

In figure 42 is shown the blinking LED.

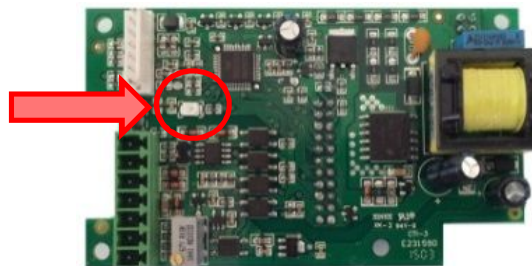

Fig. 42 – Blinking LED

In the fig 43 there is the legend for reading the alarm through the LED present on the Control Board.

Description	Blinking
Normal operation, no errors	<b>1 Blink/s</b>
Memory error	<b>2 Blink/s</b>
Short-circuit	<b>3 Blink/s</b>
Loss of synchronism with the motor	<b>4 Blink/s</b>
Input voltage outside range (only with motor stopped)	<b>4 Blink/s</b>
Bus voltage over 430V during operation (instantaneous measurement)	<b>4 Blink/s</b>
Bus voltage below 350V during operation (instantaneous measurement)	<b>4 Blink/s</b>
Input relay not closed	<b>4 Blink/s</b>
Motor cable U disconnected	<b>4 Blink/s</b>
Motor cable V disconnected	<b>4 Blink/s</b>
Motor cable W disconnected	<b>4 Blink/s</b>
Overtemperature	<b>4 Blink/s</b>
Loss of Communication	<b>4 Blink/s</b>

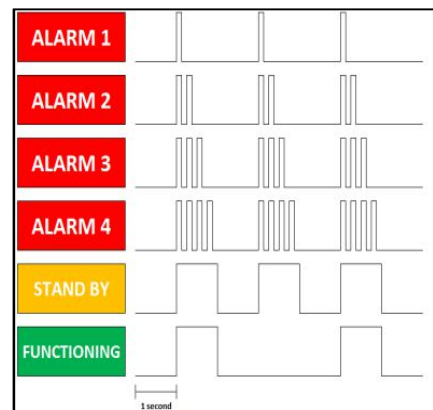

Fig. 43 – Alarm description – Blinking LED

## 8.0.4- Digital Output

The driver output can be configured as Alarm output by modifying the Holding Register 46 to value 1. During the normal functioning the output value is 0V and when an alarm occurs the output value is 5V see fig. 44

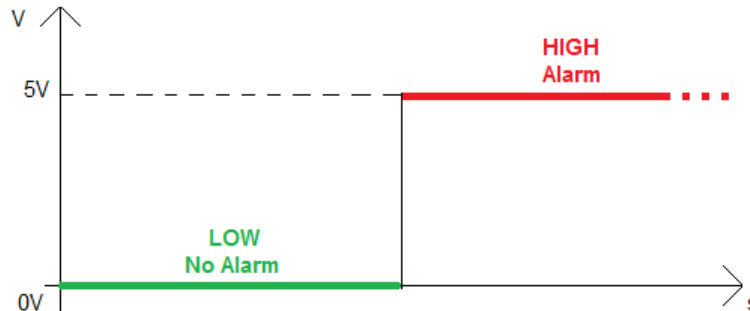

Fig. 44 – Digital Output functioning



**The output is NOT provided by a relay**  
**The output is NOT a dry contact**  
**DON'T connect power cable to the output**

## 9- AVAILABLE SOFTWARE

A freeware software is available on Nicotra|Gebhardt website (<http://www.nicotra-gebhardt.com>) for monitoring the performance of the FDP fans in the final customer units. Please refer to the “Fan Configuration Program” manual for more details.

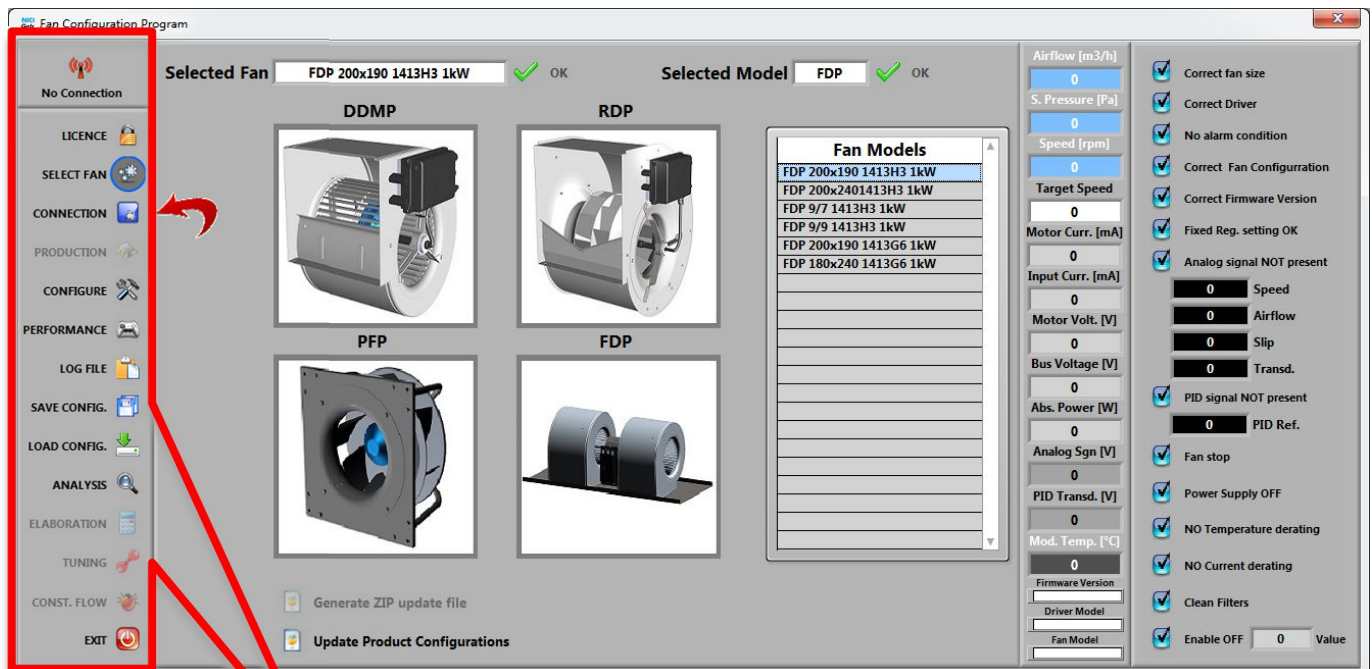

Fig. 45 – Available masks

In the figure 45 are shown all the accessible end user masks basing on the password inserted.





**NOTES**

**NOTES**

## Nicotra Gebhardt worldwide

### SPAIN

Ctra. Alcalá-Villar del Olmo, Km. 2,830  
28810 Villalbilla-Madrid  
Phone +34 918-846110  
Fax +34 918-859450  
E-mail info@nicotra.es

c/.Coso, 67-75, esc. 1.a,1.oB  
50001 Zaragoza  
Phone +34 976-290550  
Fax +34 976-298127  
E-mail gebhardt@teletel.es

### BELGIUM

Haeghensgoed, 13 - 00/01  
9270 Laarne  
Phone +32 (0)9-336-00-01  
Fax +32 (0)9-336-00-05  
E-mail info.nicotra@nicotra.be

### FRANCE

Leader's Park Bat A1  
3 chemin des Cytises  
69340 Francheville  
Phone +33 (0)4 72 79 01 20  
Fax +33 (0)4 72 79 01 21  
E-mail g.cauche@nicotra-gebhardt.com

### SWEDEN

Box 237  
Kraketorpsgatan 30  
43123 Mölndal  
Phone 0046 31-874540  
Fax 0046 31-878590  
E-mail info.se@nicotra-gebhardt.com

### GREAT BRITAIN

Unit D, Rail Mill Way  
Parkgate Business Park  
Rotherham  
South Yorkshire  
S62 6JQ  
Phone +044 01709-780760  
Fax +044 01709-780762  
E-mail sales@nicotra.co.uk

### UNITED STATES

PO BOX 900921  
Sandy, Utah 84090  
Phone 001(801) 733-0248  
Fax 001(801) 315-9400  
Mobile 001(801) 682 0898  
E-mail mike.sehgal@gebhardtffans.com  
<http://www.gebhardtffans.com/>



### MALAYSIA

Lot 1799, Jalan Balakong  
Taman Perindustrian Bukit Belimbing  
43300 Seri Kembangan  
Selangor  
Phone +603 8961-2588  
Fax +603 8961-8337  
E-mail info\_malaysia@nicotra-gebhardt.com

### THAILAND

6/29 Soi Suksawadi 2, Moo 4, Suksawadi Road,  
Kwang Jomthong, Khet Jomthong,  
Bangkok 10150  
Phone +662 476-1823-6  
Fax +662 476-1827  
E-mail sales@nicotra.co.th

### SINGAPORE

No. 15 West Coast Highway  
# 04-08 Pasir Panjang Building  
Singapore 117861  
Phone (065) 6265-1522  
Fax (065) 6265-2400  
E-mail info@gebhardt-singapore.com

### AUSTRALIA

65 Yale Drive,  
Epping, VIC 3076  
Phone +61 3 9017 5333  
Fax +61 3 8401 3969  
E-mail info@nicotra.com.au

### INDIA

Plot no 28F & 29, Sector-31,Kasna,  
Greater Noida-201 308 U.P (India)  
Phone +91 120 4783400  
Phone +91 22 65702056 (Mumbai)  
Phone +91 80 25727830 (Bangalore)  
E-mail info@nicotraindia.com

### CHINA

88 Tai'An Road, XinQiao, ShiJI, Panyu  
Guangzhou 511450  
PR CHINA  
Phone +86 (0)20-39960570  
Fax +86 (0)20-39960569  
E-mail sales@nicotra-china.com

### Nicotra Gebhardt Germany

Nicotra Gebhardt GmbH  
Gebhardtstraße 19-25  
74638 Waldenburg  
Phone +49 (0)7942 101 0  
Fax +49 (0)7942 101 170  
E-mail info@nicotra-gebhardt.com

### Nicotra Gebhardt Italy

Nicotra Gebhardt S.p.A  
Via Modena, 18  
24040 Zingonia (BG)  
Phone +39 035 873 111  
Fax +39 035 884 319  
E-mail info@nicotra-gebhardt.com

[nicotra-gebhardt.com](http://nicotra-gebhardt.com)